

Status: 01/2025

**cab**  
*we identify more*



Print and  
apply systems  
for printing with two colors

**Hermes C**

Made in Germany

# Print labels with two colors and apply them in real time

Hermes C is the world's first system for printing labels with two colors and applying them right after. It has been designed in particular for applications according to GHS.

Integral retraction enables individual labels be printed and applied on demand without loss.

All shapes of containers can be labeled, such as bottles, cans, barrels, buckets, cardboard boxes or pallets.

A modular system provides solutions for any application.



- Designed for industrial operation
- Easy to install in production lines
- Interface-based access to ERP and process control systems

For the labeling of chemicals and hazardous substances GHS and REACH demand standardized pictograms. The directives apply worldwide. Hazard symbols, such as empty diamonds, are not permitted.

Hermes C enables individual labels be designed and printed.

cab supplies labels and ribbons for Hermes C applications, certified to BS5609/3, if required (see page 11).

## Sample label

	<b>GLUTARALDEHYDE SOLUTION 50%</b>		
	23005	QTY NET 1 KG	0,88 L. BATCH: test281114
	<b>UN 3265</b>		CORROSIVE LIQUID, ACIDIC, ORGANIC, N.O.S., Glutaraldehyde
	CLASS 8 E2		CAS: 111-30-8
	<p><b>⚠ DANGER</b> Hazardous. Statements Very toxic to aquatic life. May cause respiratory irritation. May cause allergy or asthma symptoms or breathing difficulties if inhaled. May cause an allergic skin reaction. Causes severe skin burns and eye damage. Toxic if swallowed or if inhaled. Harmful to aquatic life with long lasting effects. Precautionary: Statements Avoid breathing dust / fume / gas / mist / vapors / spray. Wear protective gloves / protective clothing / eye protection / face protection. In case of inadequate ventilation wear respiratory protection. IF SWALLOWED: Immediately call a POISON CENTER or doctor / physician. IF ON SKIN (or hair): remove / take off immediately all contaminated clothing. Rinse skin with water / shower; IF IN EYES: rinse cautiously with water for several minutes. Remove contact lenses, if present and easy to do. Continue rinsing. Immediately call a POISON CENTER or doctor / physician. If experiencing respiratory symptoms: call a POISON CENTER or doctor / physician. Store in a well-ventilated place. Keep container tightly closed. Contains 1,5-pentanedial</p>		
	<p>cab Produkttechnik GmbH &amp; Co KG · Wilhelm-Schickard-Str. 14 · 76131 Karlsruhe / Germany · Emergency number +49 721 6626-0</p>		

Scopes of delivery, design and technical specifications correspond to the date of the printing. Subject to change. The data provided in the catalog do not represent any warranty or guarantee. See current data on [www.cab.de/en/hermes](http://www.cab.de/en/hermes)

## Technical details



- 1 Graphic display**  
White backlighting enables good legibility. Depending on the installation, the display can be rotated in steps of 90°.
- 2 Navigator pad**  
In addition to the display, it enables simple menu control. The day-and-night design only features operable positions.
- 3 Ribbon retainer**  
Replacing a ribbon is no big deal thanks to three-part clamping axles.
- 4 Metal chassis**  
Resistance to torsion facilitates component assembly. Made of cast aluminum
- 5 Print positioning**  
It is implemented automatically after a new roll of labels has been inserted. Reference values remain intact even when a unit is switched off.
- 6 Print heads 1 and 2**  
Select pressing force according to the width of a label.
- 7 Automatic ribbon saving**  
Print head 1 is lifted along unprinted spots of a label and the ribbon is stopped while such labels are fed.
- 8 Pulling system**  
Ball-bearing transport rollers enable accurate print images.
- 9 Label unwinder**  
A swing arm and an integral brake enable labels be unwound at constant force.
- 10 Liner rewinder**  
Subsequent to all the labels been dispensed, the entire liner tape is rewound. Rolls can be removed easily on the basis of an expanding axle.
- 11 Cover**  
It can be assembled to prevent from dust or damage.

# Required interfaces



- 1 RS232-C (limited access)
- 2 USB 2.0 slave
- 3 Ethernet 10/100 Mbit/s TCP/IP
- 4 Two USB master for plugging an external control panel, a keyboard, scanner or service key
- 5 CompactFlash Type I memory card
- 6 Warning light indicating the state of a unit
  - Green Unit ready
  - Yellow Prior warning to a label web or a ribbon ending
  - Red Error
- 7 Main valve for switching compressed air supply ON or OFF
- 8 External e-stop: In conjunction with plugging a main valve, compressed air supply can be suspended in the event of danger.
- 9 Digital I/O: SUB-D, 25 pins, compliant to IEC/EN 61131-2, types 1+3  
The inputs and outputs are galvanically isolated and protect from reverse polarity. The outputs are also short-circuit-proof.

## PNP inputs

Start printing / applying label  
 Reprint  
 Label feed  
 Delete print job  
 Pause  
 Label removed  
 Reset  
 Stop printing / applying label  
 Print first label

## PNP outputs, NPN upon request

Unit ready  
 Print data available  
 Paper feed ON  
 Prior warning to a ribbon ending  
 Prior warning to a label web ending  
 Ribbon ending  
 Label web ending  
 Label peeled off  
 Initial / upper end position  
 Label apply / lower end position  
 Collective error

# Technical data

		1.1	
Label printer		Hermes C 6L/300-3	
<b>Print head</b>			
Print method		Thermal transfer	
Print resolution	dpi	300	
Print speed	mm/s max.	125	
Print width	mm max.	162.6	
<b>Material</b>			
Labels on a roll	Paper, synthetics such as PET, PE, PP, PVC, PU, acrylate, PI		
Thickness	mm	0.03 - 0.06	
Width Label <sup>1)</sup>	mm	46 - 176	
Liner	mm	50 - 180	
Height of a label	mm	20 - 356	
Material	Speed	mm/s	100 (set by default)
backfeed	Distance	mm	115
Roll	Outside diameter	mm max.	305
	Core diameter	mm	76
	Winding	outside or inside	
<b>Ribbon</b>			
Color layer		outside or inside	
Roll	Outside diameter	mm max.	80
	Core diameter	mm	25
Length	m max.	450	
Width <sup>2)</sup>	mm max.	165	
Automatic ribbon saving on print head 1		■	
<b>Internal rewinder</b>			
Outside diameter	mm max.	210	
Core diameter	mm	76	
<b>Dimensions, Weight</b>			
Height x Depth x Width	mm	550 x 630 x 320	
Weight	kg approx.	30	
<b>Label sensor</b>			
Transmissive	detecting leading margins of a label and materials ending		
Distance to locating edge	mm	4 - 47	
<b>Electronics</b>			
Processor, 32 bit clock rate	MHz	266	
RAM	MB	64	
IFFS	MB Flash	8	
Slot for plugging CompactFlash Type I	■		
Battery for date and real time display / Data preserved if power turns off	■		
Acoustic alarm in cases of errors	■		
<b>Interfaces</b>			
RS232-C	1,200 to 230,400 baud / 8 bits ■		
USB 2.0 Hi-Speed slave for plugging a PC	■		
Ethernet 10/100 Mbit/s, LPD, RawIP printing, FTP printing, DHCP, HTTP, FTP, SMTP, SNMP, TIME, Zeroconf, mDNS, SOAP	■		
2 USB master for plugging an external control panel, a keyboard, scanner, service key	■		
Warning light	■		
Digital I/O	■		
Applicator	■		
External e-stop	■		
Compressed air main valve	■		
<b>Operating data</b>			
Voltage	100 - 240 VAC ~ 50/60 Hz, PFC		
Consumption of power	<10 W in standby / 100 W in typical operation / max. 165 W		
Temperature / humidity	Operation:	+5 - 40 °C / 10 - 85 %, not condensing	
	Stock:	0 - 60 °C / 20 - 80 %, not condensing	
	Transport:	-25 - 60 °C / 20 - 80 %, not condensing	
Approvals	CE, FCC class A, ICES-3		
<b>Control panel</b>			
Keys / LED	Pause, Feed, Cancel, Menu, Enter, 4 cursors		
LCD graphics display	Width 60 mm, height 40 mm, four lines of text		
<b>Setup options</b>			
Time, date, digital and analog clock, language and unit settings, print parameters, interfaces, security			
<b>Status bar on display</b>			
Receive data	Print head temperature	abc debug	■
Ethernet	Memory card access	Input buffer	■
Used memory	Clock / calendar	Ribbon remaining	■

■ standard □ option

<b>Controls</b>			
Print stop	End of ribbon, end of label web, print head open		
Prior warning	Ribbon ending, label web ending		
<b>Test routines</b>			
System diagnostics	upon startup, detection of print head included		
Brief status report, status printout	Fonts list, list of units, WLAN status, label profile, test grid, monitor mode, PPP status		
Status reports	- Printout of print durations, running hours, etc. - Status of a unit requested by software command - Display of errors, related to, for example, a network, a link missing, a barcode		
<b>Fonts</b>			
Types	5 bitmap fonts including OCR-A, OCR-B and 3 vector fonts Swiss 721, Swiss 721 Bold, Monospace 821 are integral, TrueType fonts are for memory.		
Sets of characters	Windows -1250 to -1257, DOS 437, 737, 775, 850, 852, 857, 862, 864, 866, 869, EBC DIC 500, ISO 8859-1 bis -10 and -13 to -16, WinOEM 720, UTF-8, MacRoman, DEC MCS, KOI8-R. All Western European and Eastern European, Latin, Cyrillic, Greek, Hebrew and Arabian characters are supported. Simplified Chinese and Thai are options		
Bitmap	1 mm to 3 mm wide and high Zoom factors 2 to 10 0°, 90°, 180°, 270° orientations		
TrueType	0.9 mm to 128 mm wide and high Continuous zoom 360° orientation in steps of 1°		
Styles	Bold, italic, underlined, outline, inverse - depending on the font type		
Character spacing	Proportional		
<b>Graphics</b>			
Elements	Lines, arrows, rectangles, circles, ellipses - filled and gradient		
Formats	PCX, IMG, BMP, TIF, MAC, GIF, PNG		
<b>Codes</b>			
1D barcodes, linear	Code 39, Code 93 Code 39 Full ASCII Code 128 A, B, C EAN 8, 13 EAN/UCC 128 EAN/UPC Appendix 2 EAN/UPC Appendix 5 FIM HIBC	Interleaved 2/5 Ident and routing code of Deutsche Post Codabar JAN 8, 13 MSI Plessey Postnet RSS 14 UPC A, E, E0	■
2D codes, stacked codes	Aztec, Codablock F, DataMatrix, PDF 417, Micro PDF 417, UPS MaxiCode, QR-Code, RSS 14 truncated, limited, stacked, omni-directional, EAN DataMatrix, GS1 Data Bar		
	All codes may vary in height, modular width and ratio. 0°, 90°, 180°, 270° orientations Feasibility of check digits, plain text printouts and start/stop coding depending on the type of code		
<b>Software</b>			
Control	Direct JScript programming abc Basic Compiler Database Connector		■ ■ ■
Administration	Printer control Administration Network Manager		■ ■
Label software	cablabel S3 Lite cablabel S3 Viewer cablabel S3 Pro cablabel S3 Print		■ ■ □ □
Windows printer drivers certified WHQL for	Windows 10 Windows 11	Server 2016 Server 2019 Server 2022	■
Stand-alone operation			■

<sup>1)</sup> Limitations may occur with small labels, slim or strongly adhesive materials. Critical applications require testing.

<sup>2)</sup> A ribbon should be at least as wide as the liner material.

# 4126/4136 stroke applicators

2.1



**Tamp-on pad**  
Labels are precisely pressed onto flat surfaces.



**Tamp-on pad, spring-mounted**  
Labels can be pressed even onto surfaces inclined by up to 8°.



**Roll-on pad**  
Labels are rolled onto the flat surfaces of items during transport.

**Silicone pads**  
are available upon request

## Stroke applicator

Labels are applied in real time from all sides onto packagings or items at rest or in motion (depending on the pad in use). Printed labels are taken over by a pad on the peel-off plate. The pad with a label are moved by a short-stroke cylinder in horizontal direction to the point of application. Labels are then applied onto items by a stroke cylinder. The length of the stroke cylinder defines the maximum distance of an item to the peel-off plate.

<b>Stroke applicator</b>		<b>4126C-300</b>	<b>4126C-400</b>	<b>4136C-300<sup>1)</sup></b>	<b>4136C-400<sup>1)</sup></b>
Cylinder stroke	mm	300	400	300	400
Height of an item		flexible	flexible	flexible	flexible
Horizontal stroke cylinder	mm	25	25	25	25
Label application		from the top, from below, from the side	from the top, from below, from the side	from the top, from below, from the side	from the top, from below, from the side
Weight of applicator	packaging excluded kg	7	7.5	6.5	7.5
Consumption of power	W max.	15	15	15	15
Compressed air	bar	4.5	4.5	4.5	4.5
Blow tube	no.	1	1	2	2
Cycle rate	labels/min approx. <sup>2)</sup>	20	20	20	20
<b>Tamp-on pad</b>		<b>4126C-11 F</b>	<b>4126C-12 F</b>	<b>4126C-19 F</b>	-
Label width	mm	46 - 174			-
Label height	mm	20 - 100			-
Distance of an item to the bottom of a unit	mm max.	220	320		-
Depth F <sup>3)</sup> of a pad immersing	mm max.	50			-
State of an item at the moment a label is applied		at rest			-
<b>Tamp-on pad, spring-mounted</b>		<b>4126C-3900</b>		<b>4136C-3900</b>	
Label width	mm	80 - 174		80 - 174	
Label height <sup>4)</sup>	mm	80 - 150		151 - 356	
Distance of an item to the bottom of a unit	mm max.	215	315	215	315
State of an item at the moment a label is applied		at rest		at rest	
<b>Roll-on pad</b>		<b>4126C-4900</b>		<b>4136C-4900</b>	
Label width	mm	50 - 174		50 - 174	
Label height <sup>4)</sup>	mm	80 - 150		151 - 356	
Distance of an item to the bottom of a unit	mm max.	245 - 275	345 - 375	275 - 360	375 - 460
State of an item at the moment a label is applied		in motion		in motion	

<sup>1)</sup> synthetic labels only    <sup>2)</sup> calculated using labels 100 mm high and a print speed of 125 mm/s

<sup>3)</sup> If an applicator immerses more than 25 mm, the cover of Hermes C must be adapted.    <sup>4)</sup> Inside-winding is preferred with labels as high as 210 mm.

# 5326/5426 vacuum belt applicators

2.2

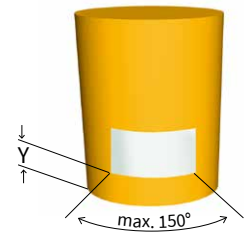
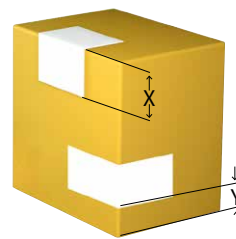
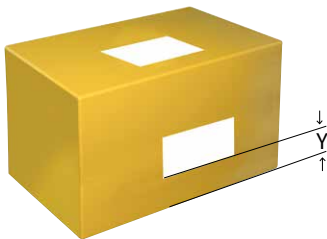

## Vacuum belt applicator

Labels are applied in real time onto packagings or items in motion. Labels can be applied from all sides onto flat or cylindric surfaces. Corner-wrap applications are as well possible.







Printed labels are taken over on the peel-off plate. They move along a vacuum belt to the point of application and are applied, triggered by an external signal. While a label is dispensed, the next one can already be printed.









Technical data	Vacuum belt applicator	
	5326C	5426C
Label application	onto flat surfaces	onto cylidric surfaces and corner-wrap
Direction to which labels are dispensed	left	left
Label width	46 - 174 mm	46 - 174
Label height	80 - 356 mm	80 - 356
State of an item at the moment a label is applied	in motion	■
Label application	from the top	■
	from below	-
	from the side	■
Height of an item	fixed	fixed
Speed of an item	0.5 m/s max.	0.3
Gap between items	1.0 min. m	0.6
Weight of applicator	packaging excluded kg	9
Consumption of power	90 W max.	90
Stability on the level a label is applied	F=mm	10 N x factor 3
Corner-wrap labeling	X mm max.	180
Cylinder labeling	diameter mm at least	depending on the length of a label
Vacuum belt speed <sup>1)</sup>	100 - 500 mm/s	100 - 300
Cycle rate <sup>2)</sup>	labels/min max.	15
Distance of a label to the conveyor belt, when applying from the side	Y mm at least	20

<sup>1)</sup> The speed of an item must be at least as high as the speed of the vacuum belt.

<sup>2)</sup> calculated using labels 100 mm high and a print speed of 100 mm/s

# Accessories

Extra Hermes C equipment	
3.1 	<b>Cover V for vertical installation</b> It prevents from dust and damage.
3.1 	<b>Cover H for horizontal installation</b> It provides an additional cover plate on the side on which items are processed.
3.2 	<b>External control panel</b> If the control panel of a printer cannot be accessed, an additional external one can be plugged. A slot for plugging a CompactFlash Type I memory card is provided, so is a USB host interface.
3.3 	<b>Standard keyboard</b> USB, 115 keys
3.4 	<b>Memory card</b> CompactFlash Type I for storing label formats, fonts, texts. Read / write graphics on a printer or PC
3.5 	<b>Product sensor, 25 pins</b> for connecting Hermes C Labels are triggered to be applied as soon as an item has been detached, e.g. on a conveyor belt.
3.6 	<b>Interface plug</b> All control signals can be attached to the I/O interface using clamping screws.

Interface	
4.1 	<b>Label selection - I/O box</b> A maximum of 16 labels per box can be selected from a memory card by a superior control unit, such as a PLC.
Connecting cable	
5.1 	<b>Connecting RS232-C cable</b> 9/9 pins, 3 m
Extra applicator equipment	
6.1 	<b>Blow tube 4"</b>
6.1 	<b>Blow tube 6"</b>
6.2 	<b>Unit for compressed air regulation</b> It is assembled to the bracket. 4.5 bar default setting
6.3 	<b>Unit for compressed air regulation providing an additional ON/OFF valve</b> If operating Hermes C in a plant, compressed air required for the applicator can be switched ON and OFF externally. 4.5 bar default setting E-stop required
6.4 	<b>Circular connector</b> 3 pins, M8, for plugging a compressed air main valve
6.4 	<b>Circular connector</b> 4 pins, M8, for plugging an e-stop
6.5 	<b>Pressure regulating valve</b> Installed on an applicator, it enables impact force be regulated.



# Accessories

3.8

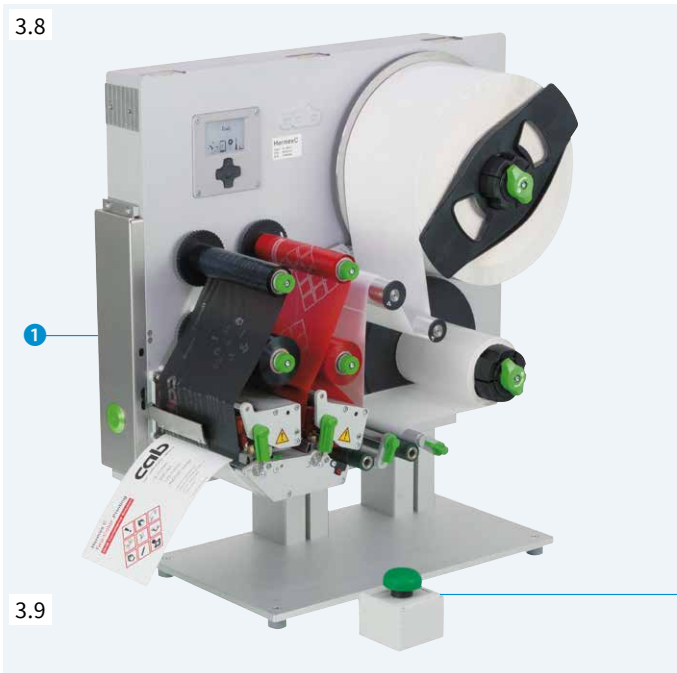

## Dispensing labels and removing them by hand

A present sensor is required, a mount recommended.  
The label printer can be assembled with or without a cover.

### 1 PS11 present sensor

#### 1. Dispensing automatically

Labels are detected in peel-off position.  
As soon as a label has been removed by hand,  
the next one is automatically printed.

#### 2. Dispensing on demand

Printing and dispensing are triggered  
by touching the key on the present sensor.

3.9

### 2 TR2 hand switch

Dispensing is triggered on demand via the I/O interface.  
The hand switch is connected by cable.

7.1



## Mount

for fixing a label printer

### 1 Adapter plate

The label printer is assembled.  
Alternatively, it can be installed directly to a production line,  
using the adapter plate and a profile.

### 2 Profile

120 mm standard length  
Further lengths can be provided upon request.

7.2



## Bracket

for assembling Hermes C in any orientation  
to a stand or a production line.

7.3

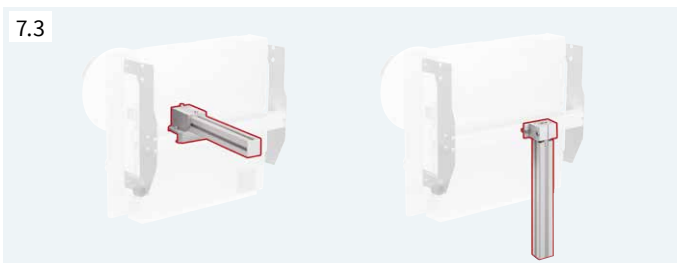

## Clamped joint designed for 50 mm x 50 mm profiles

for moving a system in horizontal or vertical direction

7.3

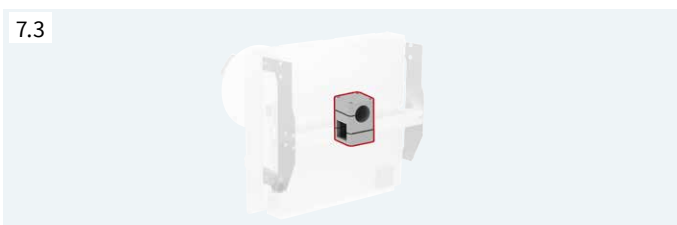

## Clamped joint designed for diameter 50 mm

for moving a system in horizontal direction  
or rotate it around an axle (diameter 50 mm)

## Stands for assembly

7.4

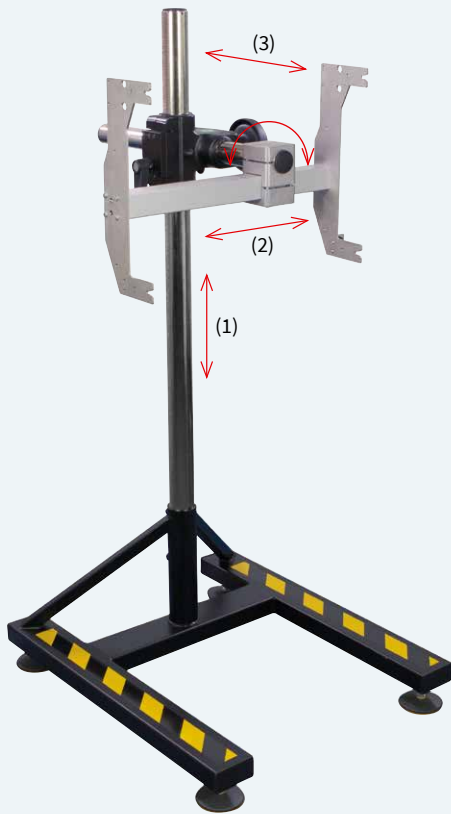

### 1622 stand

for installing Hermes C vertically in a production line.  
A crank with a toothed bar allows heights and depths be adjusted.  
In addition, Hermes C kann be rotated by 360° around its axle.

A unit for compressed air regulation can be assembled to the bracket, so can a warning light.

Technical data		1622 stand
Leveling feet	alignment in mm	± 15
Load capacity	kg max.	75
(1) Distance from the bottom of a label printer to the floor	mm	150-1,100
(2) Depth transverse to the direction of transport	mm	120
(3) Depth along the direction of transport	mm	100
(4) Rotatable	by °	± 90
Weight	kg approx.	40



7.5

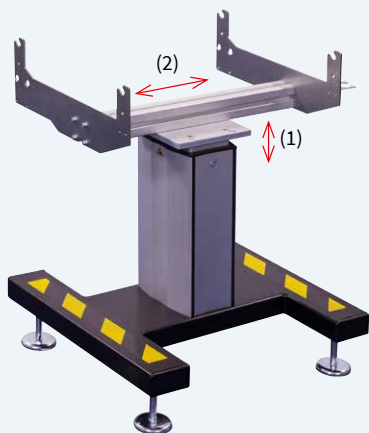

### 1221 stand

for installing Hermes C horizontally in a production line.  
An internal spindle allows heights be adjusted continuously.

A unit for compressed air regulation can be assembled to the bracket, so can a warning light.

Technical data		1221 stand
Leveling feet	alignment in mm	± 15
Load capacity	kg max.	75
(1) Distance from the bottom of a label printer to the floor <sup>1)</sup>	mm	720-960
(2) Depth along the direction of transport	mm	± 180
Weight	kg approx.	40

<sup>1)</sup> Further lengths can be provided upon request.



# Labels and ribbons

- **Printing labels with two colors in real time**
- **Designed for chemical products such as oils, paints or detergents.**
- **On barrels, buckets, containers, pallets, etc., resistant to acids and salt water**
- **Labeling according to GHS regulations**
- **Meeting British Maritime Standard BS5609, part 3.**  
In this test, labels on an aluminum barrel must still adhere and be legible after a minimum of three months in sea water.

cab provides labels made of polyester or polypropylene as well as proper ribbons. Coordinate with cab.

## Sample label



**GLUTARALDEHYDE SOLUTION 50%**

23005 QTY NET 1 KG 0,88 L. BATCH: test281114

**UN 3265**

CLASS 8 E2 CORROSIVE LIQUID, ACIDIC, ORGANIC, N.O.S., Glutaraldehyde

CAS: 111-30-8

**DANGER** Hazardous Statements Very toxic to aquatic life. May cause respiratory irritation. May cause allergy or asthma symptoms or breathing difficulties if inhaled. May cause an allergic skin reaction. Causes severe skin burns and eye damage. Toxic if swallowed or if inhaled. Harmful to aquatic life with long lasting effects. Precautionary Statements Avoid breathing dust / fume / gas / mist / vapors / spray. Wear protective gloves / protective clothing / eye protection / face protection. In case of inadequate ventilation wear respiratory protection. IF SWALLOWED: immediately call a POISON CENTER or doctor / physician. IF ON SKIN (or hair): remove / take off immediately all contaminated clothing. Rinse skin with water / shower. IF IN EYES: rinse cautiously with water for several minutes. Remove contact lenses, if present and easy to do. Continue rinsing. Immediately call a POISON CENTER or doctor / physician. If experiencing respiratory symptoms: call a POISON CENTER or doctor / physician. Store in a well-ventilated place. Keep container tightly closed. Contains 1,5-pentanedial

cab Produkttechnik GmbH & Co KG · Wilhelm-Schickard-Str. 14 · 76131 Karlsruhe / Germany · Emergency number +49 721 6626-0



### Labels

Widths from 46 mm to 176 mm and heights from 20 mm to 356 mm are manufactured for Hermes C.



### Ribbons

They match with Hermes C and the label materials and enable excellent print images at any time.

Resin resists to solvents and heat, wear and scratching.

# Software features of the label printer

J	<b>Job start</b>
H 100	<b>Speed of 100 mm/s</b>
O R	<b>Rotated by 180° in orientation</b>
S l1;0,0,68,70,100	<b>Label size 100 mm x 68 mm, gaps of 2 mm</b>
T 10, 10,0,5,pt20;sample	<b>Text / Font type: Swiss bold, 20 pt</b>
B 10,20,0,EAN-13,SC2,401234512345	<b>Barcode EAN 13, SC 2 size</b>
G 8,3.5,0;R:30,9,0.3;0.3	<b>Rectangular graphic 30 mm x 9 mm, lines 0.3 mm wide</b>
A 1	<b>1 label for printing</b>

## Direct JScript programming

Any cab printer can be programmed directly using the JScript programming language. See manual. Best support for direct programming is given by the cablabel S3 software. As an alternative, make use of any text editor.

## Connecting to SAP®

Labels can be printed from SAP<sup>1)</sup> on cab devices and systems. There are various methods:

- Printing with SAPscript
- Printing with SmartForms
- Printing with Adobe Interactive Forms

See instructions in detail on [www.cab.de/en/sap](http://www.cab.de/en/sap)

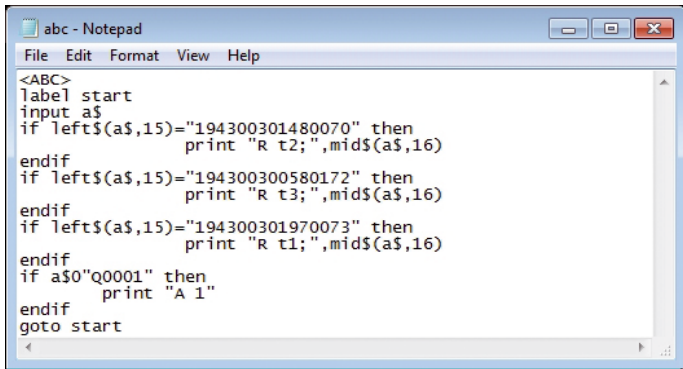

## abc Basic Compiler

Integral to the firmware, it by simple Basic programming enables data be processed before they are edited for printout. For example, external printer languages can be replaced or data be imported from other systems such as scales or PLC.

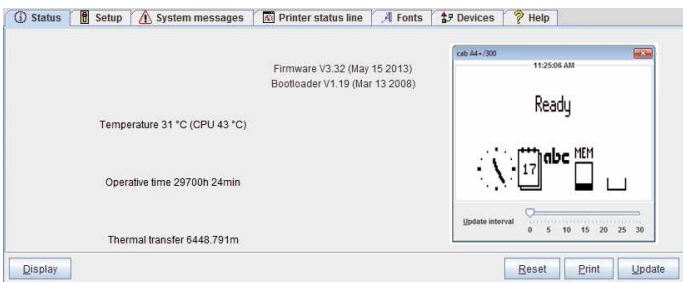

## Printer configuration on the Intranet / Internet

Integral HTTP / FTP servers enable a printer be controlled or configured, firmware be updated and memory cards be administrated using standard applications such as a web browser or a FTP client. Administrators and operators on behalf of SNMP / SMTP are notified of states, alerts and errors by email or SNMP datagrams. Time and date are synchronized by a time server.

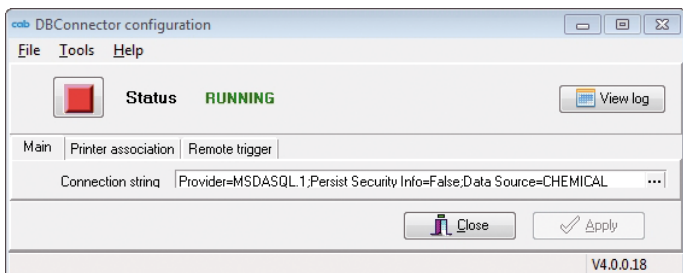

## Database Connector

Printers in a network may access data from a ODBC / OLEDB database and print it on labels. Data can be rewritten to a database while print jobs are in progress.

<sup>1)</sup> SAP and associated logos are trademarks or registered trademarks of SAP SE.

# Label software

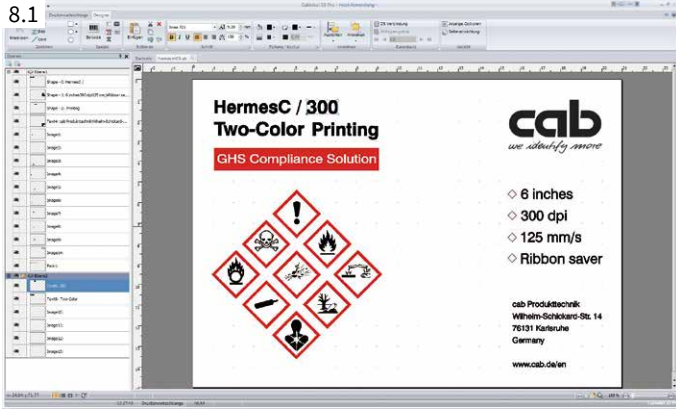

cablabel S3 is provided for Microsoft<sup>1)</sup> operating systems. Terminal servers / Citrix are not supported.

<sup>1)</sup> Microsoft is a registered trademark of the Microsoft Corporation.

cablabel S3 supports two-color design. Three features:

- Design
- Print
- Administrate

cablabel S3 opens up the full potential of cab devices. The user interface provides a comprehensive set of commands, for example different date, mathematical or logical formats.

Defining a label is first. Only when printing you decide whether to print on a label printer, a print and apply system or a marking laser system.

cablabel S3 enables a printer operate stand-alone, that is, select and print labels while not connected to a host system. Subsequent to a design, it provides all the files required for storing in the printer memory.

Modular design adapts cablabel S3 to requirements step by step. Plug-ins are embedded. Native JScript programming, for example, is supported by the JScript Viewer. The designer user interface and JScript codes synchronize in real time. Optional features can be integrated, such as the Database Connector or barcode verifiers.

# Supervising software

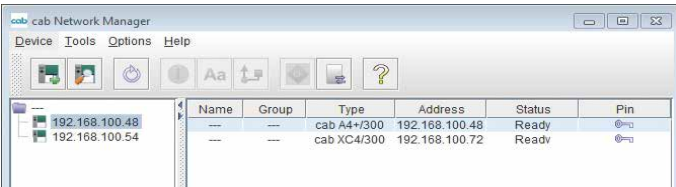

### Administration Network Manager

Users supervise a number of printers simultaneously in a network. Printers can be controlled or configured, firmware be updated, data be synchronized and memory cards and PINs be administrated all from one place.

# Printer drivers

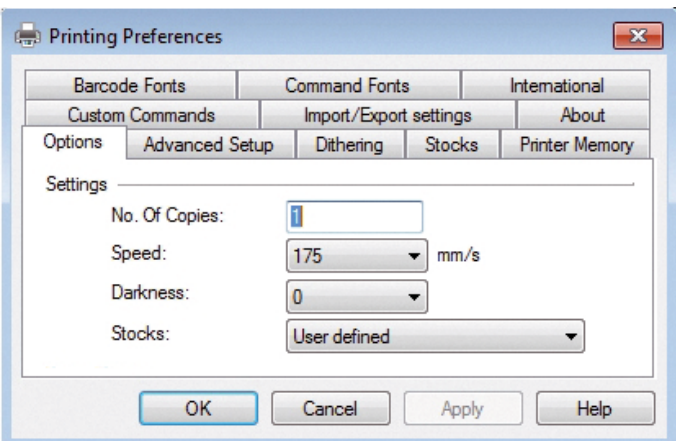



















### Windows printer drivers certified WHQL for

















- Windows 10
- Windows 11
- Windows Server 2016
- Windows Server 2019
- Windows Server 2022

Free download on [www.cab.de/en/support](http://www.cab.de/en/support)

# Delivery program

Pos.	Part no.	Unit
1.1	 5970313	Hermes C 6L/300-3 label printer
Pos.	Part no.	Applicators
2.1	 5972120 5972125 5972290 5972295	4126C-300 stroke applicator 4126C-400 stroke applicator 4136C-300 stroke applicator 4136C-400 stroke applicator
	 xxxxxxx <sup>*)</sup>	4126C-11 F tamp-on pad W x H 4126C-12 F tamp-on pad W x H 4126C-19 F tamp-on pad W x H
	 xxxxxxx <sup>*)</sup>	4126C-3900 tamp-on pad, spring-mounted, W x H
	 xxxxxxx <sup>*)</sup>	4136C-3900 tamp-on pad, spring-mounted, W x H
	 xxxxxxx <sup>*)</sup>	4126C-4900 roll-on pad W x H
2.2	 5972910 5972140	5326C vacuum belt applicator 5426C vacuum belt applicator
	 xxxxxxx <sup>*)</sup>	4136C-4900 roll-on pad W x H
Pos.	Part no.	Extra Hermes C equipment
3.1	 5970475.001	Cover V for vertical installation
	 5972493.001	Cover H for horizontal installation, cover plate included
3.2	 5954380	External control panel
3.3	 5901626	Standard USB keyboard DE
3.4	 5561043	CompactFlash Type I memory card
3.5	 5964300	Product sensor, 25 pins for connecting Hermes C
3.6	 5917651	I/O interface plug, SUB-D, 25 pins Phoenix Contact article 2761622
3.8	 5972287	PS11 present sensor
3.9	 5955710	TR2 hand switch
Pos.	Part no.	Interfaces
4.1	 5948205	Label selection - I/O box
Pos.	Part no.	Connecting cable
5.1	 5550818	Connecting RS232-C cable 9/9 pins, 3 m

<sup>\*)</sup> Part no. specific to order

Pos.	Part no.	Extra applicator equipment	
6.1	 5964095.001	Blow tube 4"	
	 5964614.001	Blow tube 6"	
6.2	 5955735	Unit L for compressed air regulation	
6.3	 5955737	Unit L for compressed air regulation providing an additional ON/OFF valve	
6.4	 5918092	Circular connector, 3 pins, M8	
	 5918003	Circular connector, 4 pins, M8	
6.5	5972xxx.212	Pressure regulating valve	
Pos.	Part no.	Tools for assembly	
7.1	 5972289	Mount 120	
	 xxxxxxx <sup>*</sup>	Mount XXX, customer-specific heights	
	 5972282	Adapter plate	
7.2	 xxxxxxx <sup>*</sup>	Profile XXX, customer-specific lengths	
	 5972291	Bracket C	
7.3	 8914443	Clamped joint, designed for 50 mm x 50 mm profile	
	 5907394	Clamped joint, designed for diameter 50 mm	
7.4	 5972230	1622 stand	
7.5	 5972447	1221 stand	
Pos.	Part no.	Label software	
8.1		Bundle (download on cab.de/en)	
		5588001	cablabel S3 Pro, 1 WS
		5588100	cablabel S3 Pro, 5 WS
		5588101	cablabel S3 Pro, 10 WS
		5588150	cablabel S3 Pro, 1 add. licence
		5588151	cablabel S3 Pro, 4 add. licences
		5588152	cablabel S3 Pro, 9 add. licences
		5588002	cablabel S3 Print, 1 WS
		5588105	cablabel S3 Print, 5 WS
		5588106	cablabel S3 Print, 10 WS
5588155	cablabel S3 Print, 1 add. licence		
5588156	cablabel S3 Print, 4 add. licences		
5588157	cablabel S3 Print, 9 add. licences		
8.2	9008486	Programming manual EN, printed copy	

# Overview of cab products

Label printers  
**MACH1, MACH2**



Label printers  
**EOS 2**



Label printers  
**EOS 5**



Label printers  
**MACH 4S**



Label printers  
**SQUIX 2**



Label printers  
**SQUIX 4**



Label printers  
**SQUIX 6.3**



Label printers  
**SQUIX 8.3**



Label printers  
**XD Q double-sided**



Label printers  
**XC Q two-colored**



Print and apply systems  
**HERMES Q**



Print and apply systems  
**Hermes C two-colored**

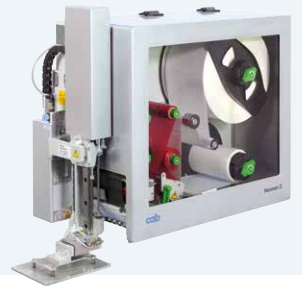

Tube labeling systems  
**AXON 1**



Print modules  
**PX Q**



Labels and ribbons



Label software  
**cablabel S3**



Label dispensers  
**HS, VS**



Labeling heads  
**IXOR**



Marking lasers  
**XENO 4**



Laser marking systems



Germany  
**cab Produkttechnik GmbH & Co KG**  
Karlsruhe  
Phone +49 721 6626 0  
[www.cab.de](http://www.cab.de)

France  
**cab Technologies S.à.r.l.**  
Niedermodern  
Phone +33 388 722501  
[www.cab.de/fr](http://www.cab.de/fr)

USA  
**cab Technology, Inc.**  
Chelmsford, MA  
Phone +1 978 250 8321  
[www.cab.de/us](http://www.cab.de/us)

Mexico  
**cab Technology, Inc.**  
Juárez  
Phone +52 656 682 4301  
[www.cab.de/es](http://www.cab.de/es)

Taiwan  
**cab Technology Co., Ltd.**  
Taipei  
Phone +886 (02) 8227 3966  
[www.cab.de/tw](http://www.cab.de/tw)

China  
**cab (Shanghai) Trading Co., Ltd.**  
Shanghai  
Phone +86 (021) 6236 3161  
[www.cab.de/cn](http://www.cab.de/cn)

Singapore  
**cab Singapore Pte. Ltd.**  
Singapore  
Phone +65 6931 9099  
[www.cab.de/en](http://www.cab.de/en)

South Africa  
**cab Technology (Pty) Ltd.**  
Randburg  
Phone +27 11 886 3580  
[www.cab.de/za](http://www.cab.de/za)

**cab // 820** distribution and service partners in more than **80** countries

