

Status: 03/2025

cab
we identify more



Linerless
print and apply
systems

HERMES QL

Made in Germany

In detail

Various linerless materials can be processed with a base unit, print rollers and applicators be selected according to an application.

Disposal of liner materials and associated costs are eliminated.

A maximum of 50 percent more labels fit onto a roll, which in turn is easier in transport. System downtimes are reduced due to fewer roll changeovers.

By activating a saving feature, material is cut automatically subsequent to a final print line and an offset.

Full compatibility: Features, dimensions and installation correspond to the tried and tested HERMES Q systems.

A large extent of applicators and assembly assistances can be used in original, HERMES Q standard and QL linerless printers be switched back and forth easily.

Cycle rates correspond to HERMES Q applicators, added by about 50 milliseconds delay time for cutting the linerless labels.



1 Metal chassis

It is the base for component assembly. Made of cast aluminum

2 Operation panel

Intuitive and easy configuration with the help of self-explanatory symbols on the user interface

3 Peripheral port

An applicator can be plugged easily and quickly.

4 Applicator

Pivotable for maintenance or material changeover

5 Cutter

for separating continuous materials

6 Unlocking lever

for pivoting and removing a cutter

Present sensor (not displayed)

for detecting print marks and print materials

7 Deflection roller

Axially adjustable for materials running straight

8 Label unwinder

Labels are unwound with consistent tractive force using a pendulum arm and an integral brake.



Cutter

It separates printed labels even in different heights.

The blade and the cutter bar each have anti-stick coating.

The entire cutter can be quickly and easily removed and reinstalled without additional tools in cases of cleaning, changing a print roller or maintaining a print head.

Print head

It is designed for direct thermal printing.

Major data such as operational performance, maximum operation temperature and heating are kept in memory. The data can be read at the premise.

Linerless print roller

Anti-stick coating

InNo-Liner print roller

DR print rollers must be used when processing continuous InNo-Liner material.

Interfaces



- 1 Port for plugging a **SD memory card**
 - 2 **2 USB hosts** for plugging a service key, an USB stick, a keyboard, a barcode scanner, an USB WLAN stick, a warning light, an external control panel
 - 3 **USB 2.0 Hi-Speed device** for plugging a PC
 - 4 **Ethernet 10/100 Mbit/s**
 - 5 **RS232C** 1,200 to 230,400 baud/8 bit
 - 6 **Digital I/O**
SUB-D socket connector, 25 pins, compliant to IEC/EN 61131-2, type 1+3
The inputs and outputs are galvanically isolated and protect from reverse polarity. The outputs are also short-circuit-proof.
- | PNP inputs | PNP, NPN outputs |
|---------------------------|-----------------------------------|
| Start printing / applying | Unit ready |
| Print first label | Print data available |
| Reprint | Initial / upper end position |
| Delete print job | Paper feed ON |
| Label removed | Label peel-off |
| Stop printing / applying | Labeling / lower end position |
| Label feed | Prior warning to label web ending |
| Pause | Label web ending |
| Reset | Collective error |

Options

- 7 **Port for additional interfaces**

Technical data

■ standard □ option

Label printer		Type	HERMES QL4.3	
Print method			Direct thermal	
Print resolution	dpi	200		300
Print speed	mm/s max.	300		300
Print width	mm max.	104		108.4
Print length	mm max.	13,500		9,000
Direction to which labels are dispensed		L = to the left, R = to the right		
Print distant to locating edge	mm	1		
Material				
Continuous linerless material wound onto a roll		Paper		
Label	Width	mm	50 - 105	
	Height	mm	30 - 456	
	Thickness	µm max.	110	
Unwinder	Roll outside diameter	mm max.	300	
	core diameter	mm	76	
	Winding	outside	■	
Printer dimensions, weights				
Width x Height x Depth		mm	260 x 400 x 400	
Weight	kg approx.	13		
with cover	kg approx.	15.5		
Label sensors				
Sensor	detecting provided material		■	
Reflective	detecting print marks from top		■	
	Sensor distant to locating edge	mm	5	
Electronics				
Processor, 32 bit clock rate	MHz	800		
RAM	MB	256		
IFFS	MB	50		
Port for plugging a SD memory card (SDHC, SDXC)		■		
Battery for indicating time and date, real-time clock		■		
Data kept in memory (e.g. serial numbers) when power turns off		■		
Interfaces				
RS232-C 1,200 to 230,400 baud / 8 bit		■		
USB 2.0 Hi-Speed device for plugging a PC		■		
Ethernet 10/100 Mbit/s IPv4 and IPv6		LPD, RawIP printing, SOAP web service, OPC UA, WebDAV, DHCP, HTTP/HTTPS, FTP/FTPS, TIME, NTP, Zeroconf, SNMP, SMTP, VNC		
2 USB hosts on the control panel, 2 USB hosts on the back of a unit		Service key, USB stick, USB WLAN stick, USB WLAN stick with a rod antenna, keyboard, barcode scanner, warning light, external control panel		
USB host, 24 VDC, for peripheral / applicator plugging		■		
Digital I/O interface providing 10 inputs and 11 outputs		■		
Operating data				
Voltage		100-240 VAC, 50/60 Hz, PFC		
Consumption of power		< 10 W in standby / 100 W in typical operation / max. 200 W		
Temperature / humidity	Operation	+5 - 40°C / 10 - 85 %, not condensing		
	Stock	0 - 60°C / 20 - 85 %, not condensing		
	Transport	-25 - 60°C / 20 - 85 %, not condensing		
Approvals		CE, FCC Class A, ICES-3		
	in preparation	UKCA, cULus, CB		
	upon request	CCC, BSMI, KC-Mark, Mexico Reg., RCM		
Control panel				
Color LCD touchscreen	Diagonal	"	4.3	
	Resolution Width x Height	px	272 x 480	

Scopes of delivery, design and technical specifications correspond to the date of the printing. Subject to change.
The data provided in the catalog do not represent any warranty or guarantee.

Technical data

■ standard □ option







Setup options		
Print Labels Peel off Apply Interfaces Error	Region: - Language - Country - Keyboard - Time zone Time Display: - Brightness - Power saving mode - Orientation Interpreter	
Status bar		
Receive data Record data stream SD memory card plugged USB stick plugged	WLAN Ethernet USB slave Time	
Controls		
Labels - prior warning - material provided - material ending	Peripheral error	
Print head	Voltage Temperature open	Cutter - pivoted - no final position
Test routines		
System diagnostics	upon startup, detection of print head included	
Information display, test printout, analysis	Status printout Fonts list List of units WLAN status Print data recorded on memory card	Test grid Label profile List of events Monitor mode
Status reports	- Printout of print durations, running hours, etc. - Status of a unit requested by software command - Display of errors related to a network, barcode or peripheral device, links missing, etc.	
Fonts		
Integral	5 bitmap fonts: 12 x 12 dots 16 x 16 dots 16 x 32 dots OCR-A OCR-B	7 vector fonts: AR Heiti Medium GB-Mono CG Triumvirate Condensed Bold Garuda HanWangHeiLight Monospace 821 Swiss 721, Bold
For memory	TrueType	
Sets of characters	Windows-1250 to -1257 DOS 437, 737, 775, 850, 852, 857, 862, 864, 866, 869 EBCDIC 500 ISO 8859-1 to -10 and -13 to -16 WinOEM 720 UTF-8 DEC MCS	
	MacRoman KOI8-R	
	Western European Eastern European Chinese, simplified Chinese, traditional Thai	Cyrillic Greek Latin Hebrew Arabian
Bitmap	1 mm to 3 mm wide and high Zoom factors 2 to 10 0°, 90°, 180°, 270° orientations	
Vector / TrueType	0.9 mm to 128 mm wide and high Continuous zoom 360° orientation in steps of 1°	
Styles	bold, italic, underlined, outline, inverse - depending on the font type	
Character spacing	proportional or monospace	
Graphics		
Elements	lines, arrows, rectangles, circles, ellipses - filled and gradient	
Formats	PCX, IMG, BMP, TIF, MAC, GIF, PNG	

Codes		
1D barcodes, linear	Code 39, Code 93 Code 39 Full ASCII Code 128 A, B, C EAN 8, 13 EAN/UCC 128/GS1-128 EAN/UPC Appendix 2 EAN/UPC Appendix 5 FIM HIBC	Interleaved 2/5 Ident and routing code of Deutsche Post Codabar JAN 8, 13 MSI Plessey Postnet RSS 14 UPC A, E, E0
2D codes, stacked codes	DataMatrix DataMatrix Rectangle Extension QR code Micro QR code GS1 QR code GS1 DataMatrix GS1 Digital Link (QR and DataMatrix) PDF 417 Micro PDF 417 UPS MaxiCode GS1 DataBar Aztec Codablock F Dotcode RSS 14 truncated, limited, stacked, omni-directional	All codes may vary in height, modular width and ratio. 0°, 90°, 180°, 270° orientations Feasibility of check digits, plain text printouts and start/stop coding depending on the type of code
Software		
Label software	cablabel S3 Lite cablabel S3 Viewer cablabel S3 Pro cablabel S3 Print	■ ■ □ □
Running also with	CODESOFT Loftware Spectrum NiceLabel BarTender	in preparation
Stand-alone operation		■
Windows printer drivers certified WHQL for	Windows 10 Windows 11	Server 2016 Server 2019 Server 2022
Apple printer drivers	Mac OS X 10.6 or any later release	
Linux printer drivers	CUPS 1.2 or any later release	
Programming	JScript printer language abc Basic Compiler ZPL II (Datastream be tested in advance)	■ ■ □
Integration	SAP Database Connector	■ ■
Administration	Printer control Configuration on the Intranet and Internet	■ ■



Free and Open Source software in cab products:
www.cab.de/opensource

HERMES QL accessories

2.1		SD memory card
2.2		USB stick
2.3		USB WLAN stick 2.4 GHz 802.11b/g/n Hotspot mode or infrastructure mode
2.4		USB WLAN stick with a rod antenna for extended range of operation 2.4 GHz 802.11b/g/n + 5 GHz 802.11a/n/ac Hotspot mode or infrastructure mode
2.6		Product sensor, 3 pins to be attached to a front side applicator, a vacuum belt applicator or an air jet box. Labels are triggered to be applied as soon as a product has been detached, e.g. on a conveyor belt.
2.7		Product sensor, 25 pins Labels are triggered to be applied as soon as a product has been detached, e.g. on a conveyor belt.
2.8		I/O interface plug, SUB-D, 25 pins All control signals are plugged to the I/O interface
2.9		Warning light States are indicated in addition to the information on the display of a printer. Red Collective error Yellow Prior warning to a label material ending Green Unit ready USB cable (1 m) for connecting to HERMES QL Assembly materials are provided only for vertical printer installation. 1 Chassis assembly 2 Bracket assembly

2.10		External control panel If the control panel of a printer cannot be accessed, an additional external one can be plugged. Same functionality as on a printer Landscape mode or portrait mode Operability as targeted, either on an external panel or on a printer
		USB 2.0 Hi-Speed device for connecting to a printer cab provides specified USB cables for power supply. Lengths 1.8 m to 16 m
2.11		Label selection - I/O box A maximum of 16 labels per box can be selected from a memory card by a superior control unit, such as a PLC.
2.12		TR2 hand switch for plugging to an I/O interface
2.13		Foot switch for plugging to an I/O interface
2.14		Connecting RS232-C cable 9/9 pins, 3 m

HERMES QL options

3.1		Cover A hinged cover with a large inspection window protects the material and the print head from contamination. Installation: vertical, rotated by $\pm 90^\circ$, horizontal
3.2		2 port Ethernet switch 10/100 Mbit/s for plugging another terminal device in a joint network. Signals are looped through.

3.3		Print roller DR4 for continuous InNo-Liner material
-----	---	---

cablabel S3 software

Design, print, administrate

cablabel S3 opens up the full potential of cab devices. Defining a label is first. Modular design adapts cablabel S3 to requirements step by step. Plug-ins are embedded. Native JScript programming, for example, is supported by the JScript Viewer. The designer user interface and JScript codes synchronize in real time. Optional features can be integrated, such as the Database Connector or barcode verifiers.

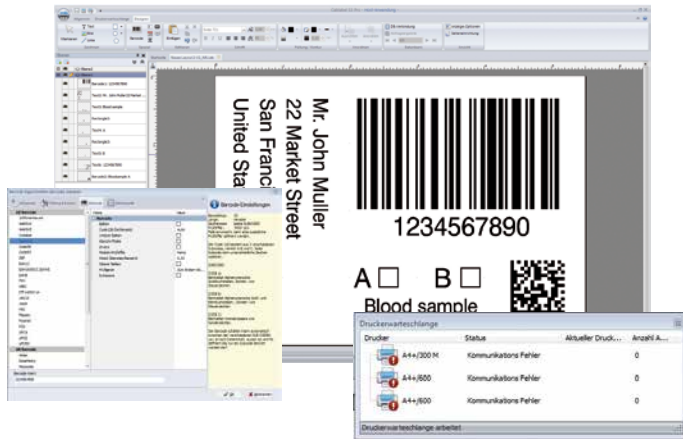

See further information on www.cab.de/en/cablabel

Stand-alone operation

This operating mode enables a printer select and print labels while not connected to a host system. Labels can be designed using software such as cablabel S3 or a text editor on a PC. Label formats, texts, graphics and data of a database can be stored on a memory card, a USB stick or a printer's IFFS memory. Only variable data are sent by a keyboard, a barcode scanner, a scale or any other host system to a printer, or be recalled by the Database Connector from a host and printed.



Printer control

Drivers



cab provides drivers for controlling a printer with software other than cablabel S3.



Free download on www.cab.de/en/support



Programming



JScript

cab printers embed JScript language.

Download free manual on www.cab.de/en/programming



abc Basic Compiler

Integral to the firmware, abc in addition to JScript enables advanced programming before data are edited for printout. For example, external printer languages can be replaced without intervening in a print job in progress. Data may be imported as well from other systems such as scales, barcode scanners or PLC.

Connecting to SAP®

Labels can be printed from SAP¹⁾ on cab devices and systems. There are various methods:

- Printing with SAPscript
- Printing with SmartForms
- Printing with Adobe Interactive Forms

See instructions in detail on www.cab.de/en/sap

Database Connector



Printers in a network may access data from an ODBC / OLEDB database and print it on labels. Data can be rewritten to a database while print jobs are in progress.

Printer administration

Configuration on the Intranet and Internet



Integral HTTP / FTP servers enable a printer be controlled or configured, firmware be updated and memory cards be administrated using standard applications such as a web browser or a FTP client. Administrators and operators on behalf of SNMP / SMTP are notified of states, alerts and errors by email or SNMP diagrams. Time and date are synchronized by a time server.

OPC UA



All the latest cab printers have been designed ready for interacting with machines and components of different manufacturers in industrial plants. An OPC UA server is part of the firmware.

See further information on www.cab.de/en/opcu

¹⁾ SAP and associated logos are trademarks or registered trademarks of SAP SE.

Linerless / InNo-Liner applicators



Automatic labeling

HERMES HQ / HQI applicators are a further development of the proven HERMES applicators, fully compatible, adding extra functions. Existing applications can continue without limitations.

Easy to configure

The applicator can be fully set on the printer control panel, configurations be stored and called up. Automatic calibration features speed up the setup.

Process control

Detailed statistical values are provided, so are sophisticated error messages. Constant control enables response right away in events of errors.

Updates

Applicator firmware can be updated on the printer control panel or the printer's web server. New features and specific solutions can therefore be tested right away and distributed in the field.

1 Long product life

by a precise and low-wear linear guide

2 Products of variable heights

Labels can be applied on different heights using a stroke cylinder. Its standard lengths are 200, 300, 400 and 600 mm.

3 Protective chassis

is a standard to protect the cylinder and the guide. It can be provided adapted to the product jig on a labeling workstation.

4 Highly reliable processes

Support air and intake air can be defined, so can stroke speed. Sensor control

5 Label application

in real time. Small or large labels, 30 to 456 mm high and 50 to 105 mm wide, can be processed using an applicator

6 Pivoting applicator

The print mechanics can be accessed quickly and easily in case of maintenance or if materials have to be replaced.

Options:

Pressure-reducing valve

It reduces the pressure exerted by the stroke cylinder to a product.

Pressure-reduced applicator

It has been designed for manual workstations missing a protective cover. The cylinder diameter is reduced to 12 mm. To prevent from injuries, a safety valve limits compressed air to a maximum of 4.8 bar.



Applicators, transfer modules and options

Overview

Applicators	Liner-less	InNo-Liner	Page	HERMES QL4.3	Universal pad with sliding foil	Tamp-on pad with sliding foil	Blow-on pad with sliding foil	Tamp-on pad, spring-mounted	Universal pad, spring-mounted with sliding foil	Tamp-on pad, spring-mounted with sliding foil	Roll-on pad with sliding foil	Corner-wrap pad with sliding foil	Transportation belt	Vacuum pad	Pressure-reducing valve	Pressure-reduced applicator
				Order code												
Front side applicator	<input type="checkbox"/>		12	HQ 3014		<input type="checkbox"/>	<input type="checkbox"/>			<input type="checkbox"/>						
Stroke applicator	<input type="checkbox"/>		14/15	HQ 4014	<input type="checkbox"/>	F	<input type="checkbox"/>		<input type="checkbox"/>	<input type="checkbox"/>	<input type="checkbox"/>	<input type="checkbox"/>			<input type="checkbox"/>	<input type="checkbox"/>
Stroke applicator	<input type="checkbox"/>		10	HQ 4024				<input type="checkbox"/>							<input type="checkbox"/>	<input type="checkbox"/>
Stroke applicator		<input type="checkbox"/>	11	HQI 4034				<input type="checkbox"/>							<input type="checkbox"/>	<input type="checkbox"/>
Stroke blow applicator	<input type="checkbox"/>		13	HQ 4614			<input type="checkbox"/>									
Vacuum belt applicator	<input type="checkbox"/>		16	HQ 5314									<input type="checkbox"/>			
	<input type="checkbox"/>		17	HQ 5414									<input type="checkbox"/>			
Air jet box	<input type="checkbox"/>		18	HQ 6114										<input type="checkbox"/>		

Applicator type code index

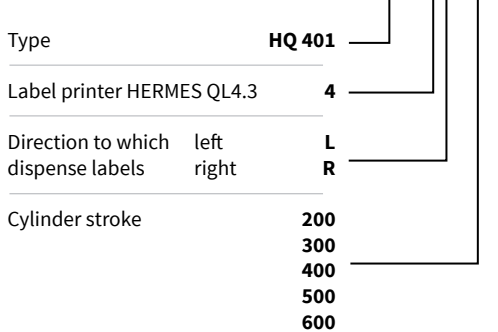

Transfer module type code index

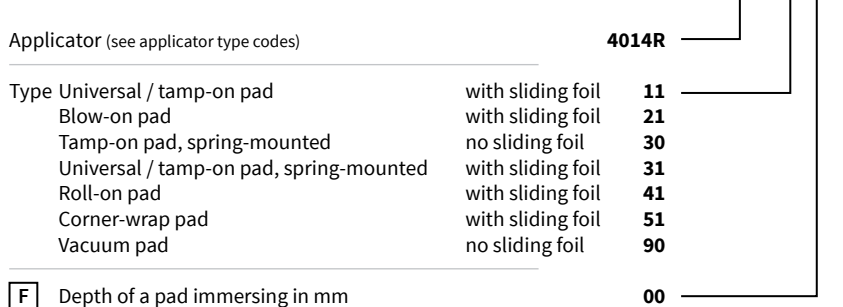

F Depth of a pad immersing in mm

A pad dips into a surface in the range of a label. See specified depths of immersion in the technical data of an applicator.

HQ 4024 stroke applicators for linerless

- As much as 90 percent savings of compressed air
- Labels applied onto variable heights using one tamp pad

Labels are applied in real time onto packages of different heights.

A spring-mounted tamp pad enables labels be applied reliably even onto inclined surfaces. Three pads are provided for labels as high as 30 mm to 100 mm, 150 mm and 200 mm. Labels may be 50 mm to 105 mm wide in each case.

Labels are sucked by an electrically driven fan.
Only the stroke cylinder requires compressed air.



Accessory

5.14 Unit to regulate compressed air



Option

5.17 Pressure-reducing valve



Stroke applicator		HQ 4024 L/R-200	HQ 4024 L/R-300	HQ 4024 L/R-400	HQ 4024 L/R-600
Distance of a package to the bottom of a unit	mm max.	135	235	335	535
Package height	mm	variable			
Alternation in the height of packages	mm max.	100	200	300	500
Direction from which labels are applied		from the top, from below, from the side			from the top
State of a package at the moment a label is applied		at rest			
Control	Sensor 1	initial / upper end position			
	Sensor 2	label on tamp-on pad			
	Sensor 3	labeling / lower end position			
Consumption of power	W max.	30			
Compressed air	bar	4.5			
Cycle rate ¹⁾	labels/min approx.	30			

¹⁾ calculated using a stroke of 100 mm below a unit, labels 40 mm high, a print speed of 100 mm/s

					
Tamp-on pad, spring-mounted			4024-3000 105 x 100	4024-3000 105 x 150	4024-3000 105 x 200
Label	Width	mm	50 - 105	50 - 105	50 - 105
	Height	mm	30 - 100	80 - 150	120 - 200
	Thickness	µm	110	110	110

HQI 4034 stroke applicators for InNo-Liner

- As much as 90 percent savings of compressed air
- Labels applied onto variable heights using one tamp pad

Labels are applied in real time onto packages of different heights.

A spring-mounted tamp pad enables labels be applied reliably even onto inclined surfaces. Three pads are provided for labels as high as 30 mm to 100 mm, 150 mm and 200 mm. Labels may be 50 mm to 105 mm wide in each case.

Labels are sucked by an electrically driven fan.
Only the stroke cylinder requires compressed air.



Accessory

5.14 Unit to regulate compressed air

Option

5.17 Pressure-reducing valve



Stroke applicator		HQI 4034 L/R-200	HQI 4034 L/R-300	HQI 4034 L/R-400	HQI 4034 L/R-600
Distance of a package to the bottom of a unit	mm max.	135	235	335	535
Package height	mm	variable			
Alternation in the height of packages	mm max.	100	200	300	500
Direction from which labels are applied	from the top	■	■	■	■
State of a package at the moment a label is applied		at rest			
Controls	Sensor 1	initial / upper end position			
	Sensor 2	label on tamp-on pad			
	Sensor 3	labeling / lower end position			
Consumption of power	W max.	30			
Compressed air	bar	4.5			
Cycle rate ¹⁾	labels/min approx.	25			

¹⁾ calculated using a stroke of 100 mm below a unit, labels 40 mm high, a print speed of 100 mm/s

Tamp-on pad, spring-mounted			4024-3000 105 x 100	4024-3000 105 x 150	4024-3000 105 x 200
Label	Width	mm	50 - 105	50 - 105	50 - 105
	Height	mm	30 - 100	80 - 150	120 - 200
	Thickness	µm	110	110	110

HQ 3014 front side applicators for linerless

Labels are applied in real time preferably from the top or from the side onto the front or back of packages in motion.

The pad locates in front of the peel-off plate. Printed labels are taken over and set onto packages by a rotary cylinder. A sensor detects each package and triggers the pivot arm / pad to its initial position.

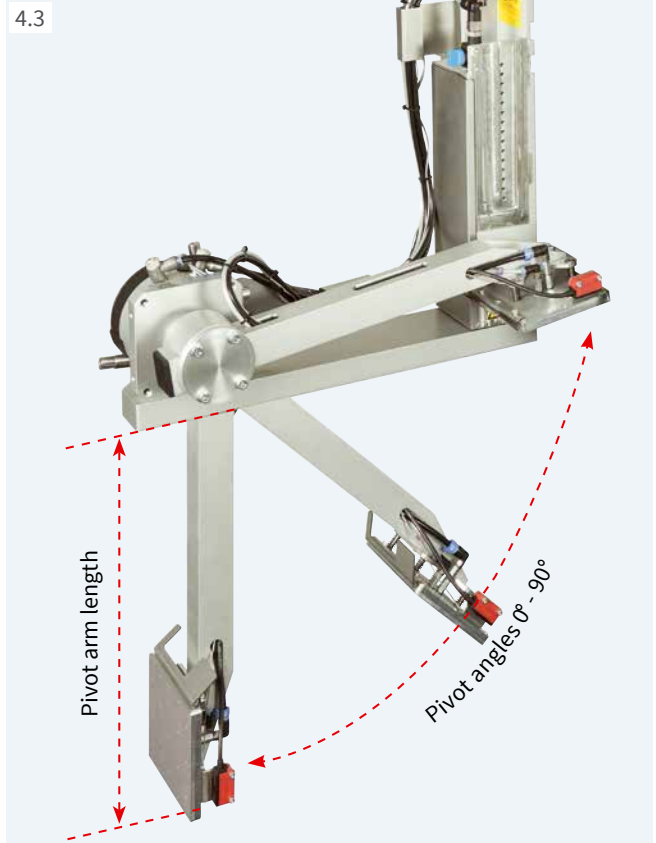
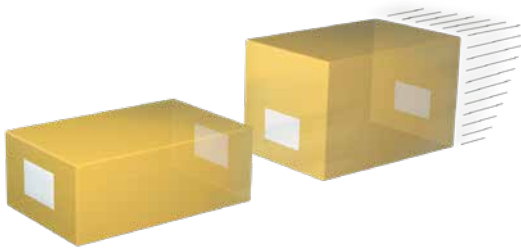

Accessories

5.13 **Blow tube**

5.14 **Unit to regulate compressed air**

Front side applicator	HQ 3014 L/R-200	HQ 3014 L/R-300	HQ 3014 L/R-400	HQ 3014 L/R-600	
State of a package	at rest		■		
at the moment a label is applied	in motion		■		
Direction from which labels are applied	from the top, from the side, from the front, from the back				
Package height	variable		■		
Pivot arm length ¹⁾	mm	200	300	400	600
Pivot angle			0° - 90°		
Weight of applicator	packaging excluded kg	9	9.5	10.5	11.5
Consumption of power	W max.		15		
Compressed air	bar		4.5		
Cycle rate ²⁾	labels/min approx.		15		

¹⁾ Pivot arm length defines the targeted spot of a label (lower margin) set 90° below a HERMES QL footprint.

²⁾ calculated using a pivot arm 200 mm long, labels 100 mm high, a print speed of 100 mm/s



Tamp-on pad

Labels are precisely tamped onto plane, even recessed, surfaces.



Tamp-on pad, spring-mounted

Labels are applied onto surfaces inclined as much as 15° using a spring-mounted vacuum plate. Height within a label area may vary by 10 mm.



Blow-on pad

Labels are blown onto the surfaces of packages by a blast of air, bridging a distance of 5 mm to 10 mm.

Transfer module		Tamp-on pad 3014 L/R 1100	Tamp-on pad, spring-mounted 3014 L/R 3100	Blow-on pad 3014 L/R 2100	
Label width	HERMES QL4.3	mm	50 - 105	80 - 105	50 - 105
Label height		mm	30 - 250	80 - 250	30 - 100

HQ 4614 stroke blow applicators for linerless

Labels are applied in real time from all sides onto packages of various heights in motion.

The pad locates in front of the peel-off plate. Printed labels are taken over. A sensor triggers the stroke cylinder direct the pad to a target spot approximately 10 mm above a package. The length of the stroke cylinder defines how far packages may differ in heights.

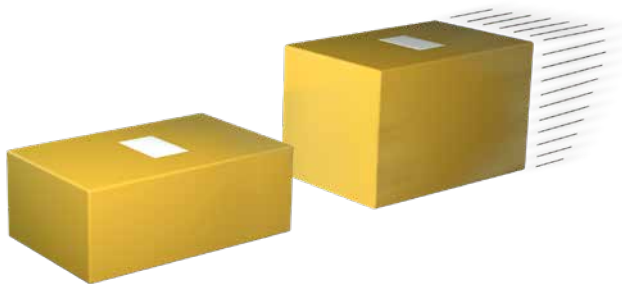

Accessories

5.13 **Blow tube**

5.14 **Unit to regulate compressed air**

4.4



Stroke blow applicator		HQ 4614 L/R-200	HQ 4614 L/R-300	HQ 4614 L/R-400
Distance of a package to the bottom of a unit	mm max.	140	240	340
Package height	variable	■		
Direction from which labels are applied		from the top, from below, from the side		
State of a package at the moment a label is applied	at rest in motion	■ ■	■ ■	■ ■
Weight of applicator	packaging excluded kg	not specified	5.5	6.5
Consumption of power	W max.		15	
Compressed air	bar		4.5	
Cycle rate ¹⁾	labels/min approx.		25	

¹⁾ calculated using a stroke of 100 mm below a unit, labels 100 mm high, a print speed of 100 mm/s

Blow-on pad

Labels are blown onto the surfaces of packages by a blast of air, bridging a distance of 5 mm to 10 mm.



Blow-on pad			4614L/R-2100 W x H
Label width	HERMES QL4.3	mm	50 -105
Label height	HERMES QL4.3	mm	30 -100

HQ 4014 stroke applicators for linerless

Labels are applied in real time preferably onto packages. The type of pad defines whether a package has to be at rest or may be in motion at the time a label is applied. Labels can be applied from all sides.

The pad locates in front of the peel-off plate. Printed labels are taken over and set onto packages by a stroke cylinder. A sensor detects each package and triggers the pad to its initial position.

The length of the stroke cylinder defines the maximum distance of a package to the peel-off plate.



Accessories

5.13 **Blow tube**

5.14 **Unit to regulate compressed air**

Options

5.17 **Pressure-reducing valve**

5.18 **Pressure-reduced applicator**

4.5



Stroke applicator		HQ 4014L/R-200	HQ 4014L/R-300	HQ 4014L/R-400	HQ 4014L/R-600
Package height	variable			■	
State of a package at the moment a label is applied	at rest			■	
Direction from which labels are applied		from the top, from below, from the side			from the top, from below
Distance of a package to the bottom of a unit	mm max.	130	230	330	530
Weight of applicator	packaging excluded kg	5	5	7	9
Consumption of power	W max.			15	
Compressed air	bar			4.5	
Cycle rate ¹⁾	labels/min approx.			25	

¹⁾ calculated using a stroke of 100 mm below a unit, labels 100 mm high, a print speed of 100 mm/s



Tamp-on pad

Labels are precisely tamped onto plane, even recessed, surfaces.

Universal pad

Labels are tamped onto flat surfaces. Drilled vacuum holes (in gaps of 5 mm) for sucking labels are covered by sliding foil and can be opened according to a label size using a perforation tool. Delivery includes two extra foils for replacement.

Tamp-on pad, spring-mounted

Labels are applied onto surfaces inclined as much as 15° using a spring-mounted vacuum plate. Height within a label area may vary by 10 mm.

Universal pad, spring-mounted

Labels are applied onto surfaces inclined as much as 15° using a spring-mounted vacuum plate. Height within a label area may vary by 10 mm. Drilled vacuum holes (in gaps of 5 mm) for sucking labels are covered by sliding foil and can be opened according to a label size using a perforation tool. Delivery includes two extra foils for replacement.

Transfer module		Tamp-on pad	Universal pad	Tamp-on pad, spring-mounted	Universal pad, spring-mounted
		4014 L/R 11 F	4014 L/R 1100	4014 L/R 3100	4014 L/R 3100
Label width	HERMES QL4.3	mm	50 -105	75 / 90	80 -105
Label height	HERMES QL4.3	mm	30 -210	60 / 90	80 -210
Depth of a pad immersing F ²⁾		mm max.	140	-	-

²⁾ on a cover HERMES QL2/QL4/QL4.3, dimension F standard 60 mm (100 mm an option, a maximum of 120 mm upon request)

HQ 4014 stroke applicators for linerless

Labels are applied in real time onto packages.
 The type of pad defines whether a package has to be at rest or may be in motion at the time a label is applied.
 Labels can be applied from all sides.

The pad locates in front of the peel-off plate. Printed labels are taken over and set onto packages by a stroke cylinder.
 A sensor detects each package and triggers the pad to its initial position.

The length of the stroke cylinder defines the maximum distance of a package to the peel-off plate.

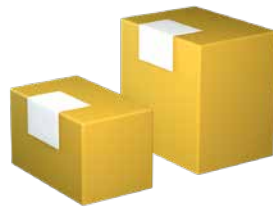

Accessories

- 5.13 **Blow tube**
- 5.14 **Unit to regulate compressed air**

Options

- 5.17 **Pressure-reducing valve**
- 5.18 **Pressure-reduced applicator**



Stroke applicator	HQ 4014L/R-200	HQ 4014L/R-300	HQ 4014L/R-400	HQ 4014L/R-600
State of a package at rest	Blow-on pad, corner-wrap pad			
at the moment a label is applied in motion	Blow-on pad, roll-on pad			
Direction from which labels are applied from the top	Blow-on pad, roll-on pad, corner-wrap pad			
from below	Blow-on pad, roll-on pad			
from the side	Blow-on pad, Roll-on pad			
Distance of a package to the bottom of a unit	140	240	340	540
Blow-on pad mm max.				
Roll-on pad mm max.	160	260	360	560
Corner-wrap pad mm max.	100	200	300	500
Package height uniform	Blow-on pad			
variable	Blow-on pad, corner-wrap pad			
Weight of applicator packaging excluded kg	5	5	7	9
Consumption of power W max.	15			
Compressed air bar	4.5			
Cycle rate ¹⁾ labels/min approx.	25			

¹⁾ calculated using a stroke of 100 mm below a unit, labels 100 mm high, a print speed of 100 mm/s



Blow-on pad

Labels are blown onto sensitive surfaces or packages in motion by a blast of air.
 Distances of 5 mm to 10 mm to of a package are set by a stop on the stroke cylinder.



Roll-on pad

Labels are rolled onto plane packages in motion.



Corner-wrap pad

Labels are applied to two adjacent sides of a package. The pad applies the first half of a label onto the top of the package. The second half is then rolled on.

Transfer module		Blow-on pad 4014 L/R 2100	Roll-on pad 4014 L/R 4100	Corner-wrap pad 4014 L/R 5100
Label width	HERMES QL4.3	mm	50 - 105	50 - 105
Label height	HERMES QL4.3	mm	30 - 100	60 - 210

HQ 5314 vacuum belt applicators for linerless

Labels can be applied in real time from all sides onto plane packages in motion.

The applicator locates in front of the peel-off plate. Printed labels are guided along a vacuum belt to a target point. Applications onto packagings are triggered by an external signal.

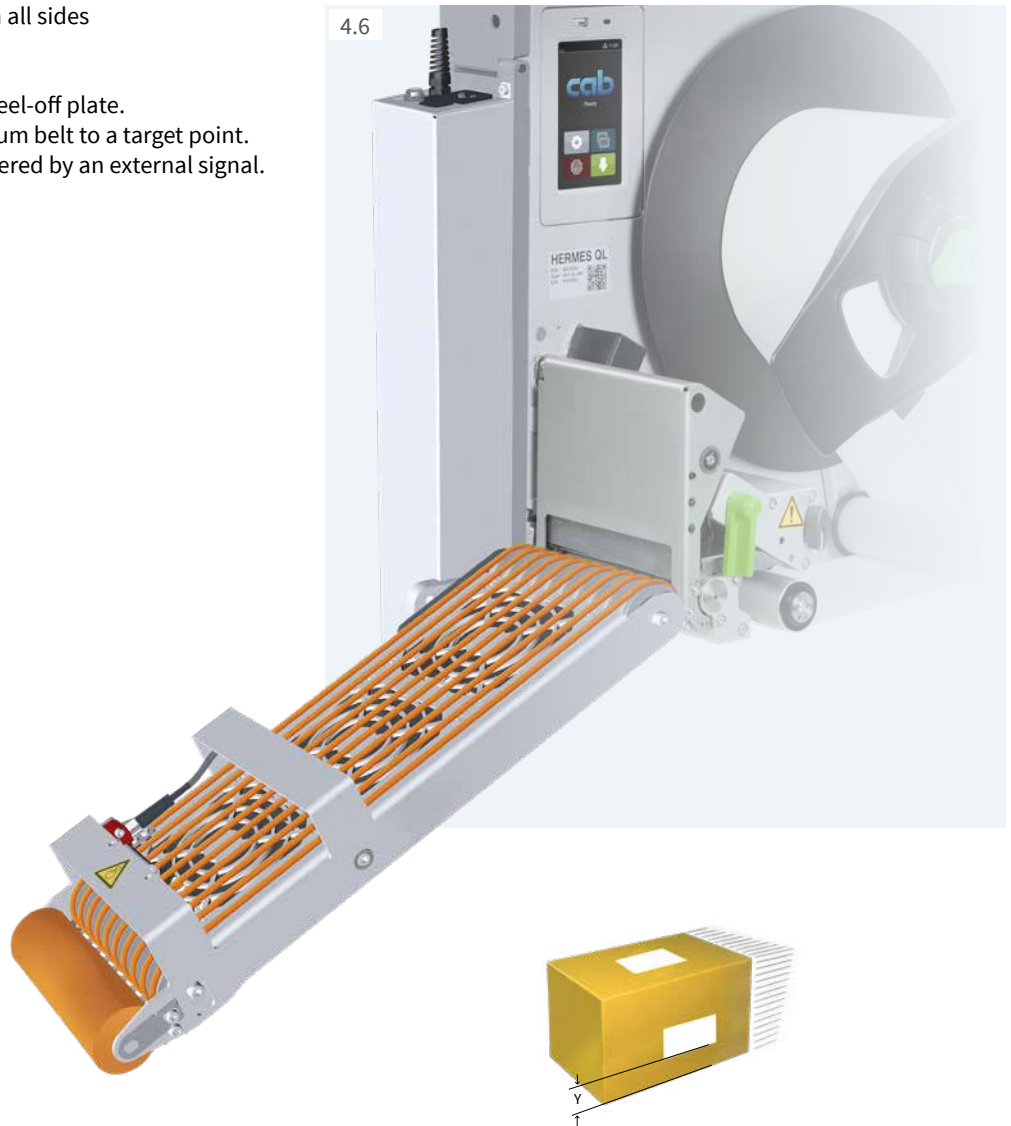

Vacuum belt applicator		HQ 5314-2	HQ 5314-3	HQ 5314-4
Label application		onto plane surfaces		
Direction to which dispense labels		left and right		
Label width	HERMES QL4.3 mm	20 - 114	20 - 114	20 - 114
Label height	mm	60 - 256	60 - 356	60 - 456
State of a package at the moment a label is applied	in motion	■		
Direction from which labels are applied		from the top, from below, from the side		
Package height	uniform	■		
Package speed	m/s max.	0.5		
Gap between packages	m at least	0.5		
Vacuum belt speed ¹⁾	mm/s	100 - 500		
Weight of applicator	packaging excluded kg	7	7	7
Consumption of power	W max.	90		
Cycle rate ²⁾	labels/min max.	30		
Distance of a label to the belt, when applying from the side	mm	Y = 20		

¹⁾ The speed of a package must be at least as high as the speed of the vacuum belt.

²⁾ calculated using labels 100 mm high and a print speed of 250 mm/s

HQ 5414 vacuum belt applicators for linerless

Labels can be applied from the top or from the side onto cylindric packages in motion. Corner-wrap applications are as well possible.

The applicator locates in front of the peel-off plate. Printed labels are guided along a vacuum belt to a target point. Applications onto packagings are triggered by an external signal.



Vacuum belt applicator		HQ 5414-3	HQ 5414-4
Label application		onto cylindric surfaces, corner-wrap	
Direction to which dispense labels		left and right	
Label width	HERMES QL4.3 mm	20 - 114	20 - 114
Label height	mm	80 - 356	80 - 456
State of a package at the moment a label is applied	in motion	■	
Direction from which labels are applied		from the top, from the side	
Package height	uniform	■	
	variable	■	
Package speed	m/s max.	0.3	
Gap between packages	m at least	0.5	
Steadiness at application level		F ¹⁾ = 30 N	
Corner-wrap label application	mm max.	X = 160	
Vacuum belt speed ²⁾	mm/s	100 - 300	
Weight of applicator	packaging excluded kg	7	7
Consumption of power	W max.	90	
Cycle rate ³⁾	labels/min max.	15	
Distance of a label to the belt, when applying from the side	mm	Y = 20	

¹⁾ F = force required for pivoting vacuum belt

²⁾ The speed of a package must be at least as high as the speed of the vacuum belt.

³⁾ calculated using labels 100 mm high and a print speed of 250 mm/s

HQ 6114 air jet box for linerless

Labels are applied onto packages in motion or at rest. Each label is sucked by a fan and blown off by an aligned blast of air. Subject to the size of a label, distances as wide as 200 mm can be bridged between a package and the peel-off plate.

1 Template

for covering all vacuum and blow-off drillings next to a label

Pre-scored in an 8 mm x 8 mm pattern, they can be easily adapted to the size of a label. All areas next to a label are covered when inserting between a vacuum block and slide rails. Delivery includes five templates.

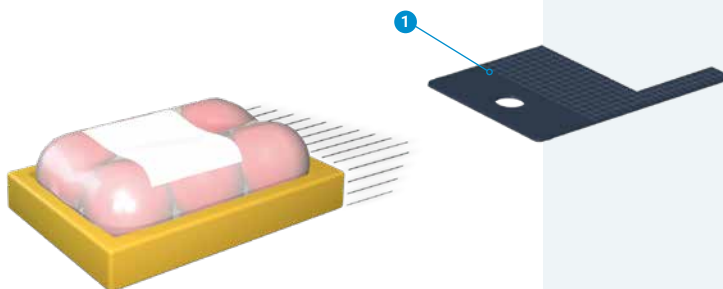

4.8



Accessories

Blow tube

Unit to regulate compressed air, providing a shut-off valve

Air jet box			HQ 6114 L/R
Label width	HERMES QL4.3	mm	50 -114 (smaller sizes upon request)
Label height		mm	50 -125 (smaller sizes upon request)
State of a package		at rest	■
at the moment a label is applied		in motion	■
Direction from which labels are applied			from the top, from below, from the side
Package height		variable	■
Distance of a package to peel-off plate		mm max.	200
Weight of air jet box		packaging excluded kg	4
Consumption of power		W max.	90
Compressed air		bar	4.5
Cycle rate ¹⁾		labels/min max.	100

¹⁾ calculated using labels 50 mm high, a print speed of 250 mm/s, a blast of air lasting 100 ms, with packages located 100 mm to the peel-off plate

Continuous linerless materials

Linerless RL540

On packaging of all kinds in industry and logistics

InNo-Liner IDL

On absorbent cardboard and paper surfaces, such as shipping labels in logistics

All materials are free from bisphenols and suit for use in food business.



- CO² neutral
- waste is avoided



Material	Linerless RL540	InNo-Liner IDL
Type	Direct thermal paper, white	Direct thermal paper, white
Thickness	approx. 80 µm	84 µm
Adhesive	self-adhesive	triggered by water
Grip	permanent	permanent
Food recommendation	not specified	BfR XXXVI
Application temperature	from 5°C	10°C - 30°C
Service		
- Temperature	-10°C - 100°C	-20°C - 50°C
- Humidity	not specified	20 % - 85 %, not condensing
Shelf life	12 months	24 months ¹⁾
- Temperature	23°C ± 5°C	20°C - 25°C
- Humidity	50 % ± 10 %	40 % - 50 %, not condensing
Application	indoor	indoor

¹⁾ subsequent to date of manufacture; warehouse conditions as defined by FINAT

Material	Item no.	Material width mm	Material length m	Roll diameter mm	Core diameter mm	Winding
Linerless RL540, 58 mm x 700 m	5780400	58	700	300	76	outside
Linerless RL540, 80 mm x 700 m	5780401	80	700	300	76	outside
Linerless RL540, 105 mm x 700 m	5780402	105	700	300	76	outside
InNo-Liner IDL, 60 mm x 750 m	5780300	60	750	300	76	outside
InNo-Liner IDL, 80 mm x 750 m	5780301	80	750	300	76	outside
InNo-Liner IDL, 100 mm x 750 m	5780302	100	750	300	76	outside

In comparison

Adhesive label with a liner

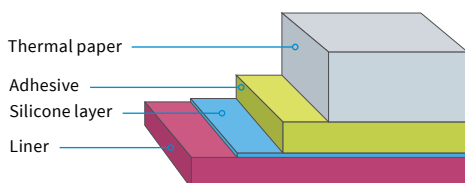

Linerless RL540

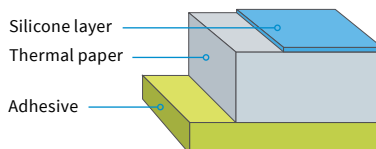

InNo-Liner IDL

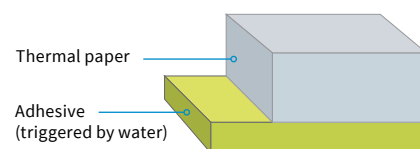

Applicator accessories

5.13



Blow tube

to provide support air. To assist label transfer, the label is blown from below to the pad.

Provided for 2", 4" or 6" label applications

5.14



Unit to regulate compressed air

4.5 bar default setting

Provided in a left-hand or right-hand design

Delivery includes a fine filter, a pressure control valve with a display, a hose to connect to an applicator's compressed air input and material to assemble the unit to a chassis or a bracket.

5.16



Unit to regulate compressed air, providing a shut-off valve to vent a hose line subsequent to the unit

Provided in a left-hand or right-hand design

5.17



Pressure-reducing valve

It reduces the pressure exerted by the stroke cylinder to an item.

5.18



Pressure-reduced applicator

It has been designed for manual workstations missing a protective cover. The cylinder diameter is reduced to 12 mm. To prevent from injuries, a safety valve limits compressed air to a maximum of 4.8 bar.

HERMES QL assembly assistance



Mount

for desktop setup or installation into production lines
 Provided in a left-hand or right-hand design

The size can be individually adapted to any operation.

6.1

1 Adapter plate

for fixing a print and apply system.

Alternatively, a system can be assembled directly into a production line, using the adapter plate and a profile.

6.2

2 Profile

Aluminum square

Standard lengths 40, 80, 120, 160, 200, 300 mm

6.3

3 Base plate

for fixing a product jig

Standard dimensions 500 mm x 255 mm

6.4

4 Base plate, xy stop and product sensor included

Standard dimensions 500 mm x 255 mm

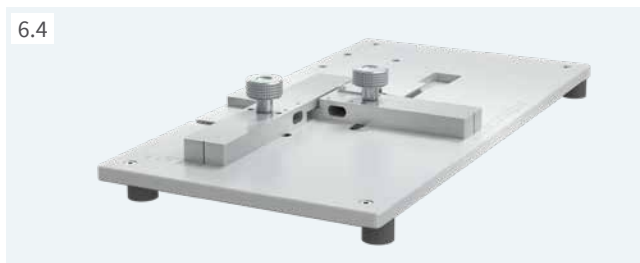

HERMES QL assembly assistance



Bracket
to assemble to a floor stand

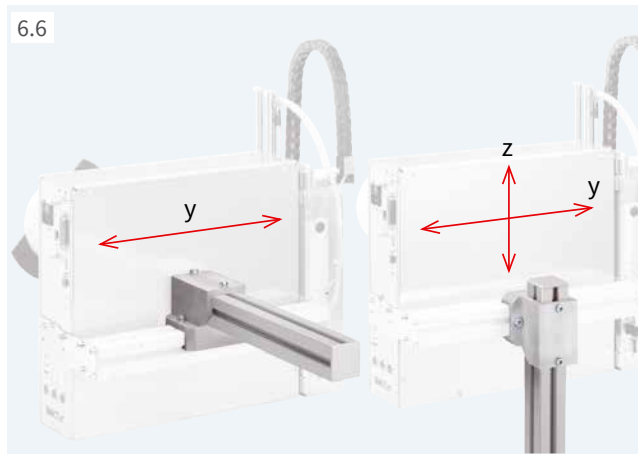

Clamped joint designed for a 50 x 50 mm profile
to move in horizontal or vertical direction

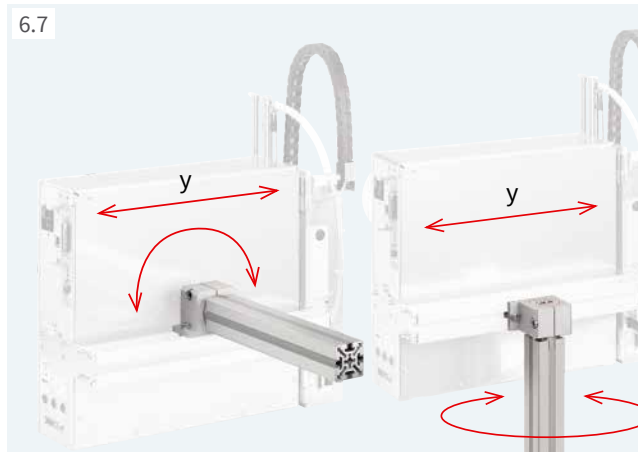

Flanged joint designed for a 50 x 50 mm profile
to move in horizontal direction or rotate around an axis

HERMES QL installation

Applying labels in direction of transport
from the top from the side

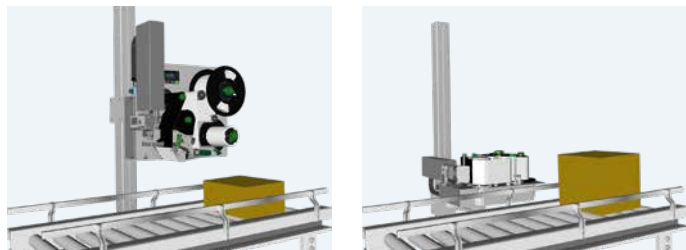

Applying labels crosswise the direction of transport
from the top from the side

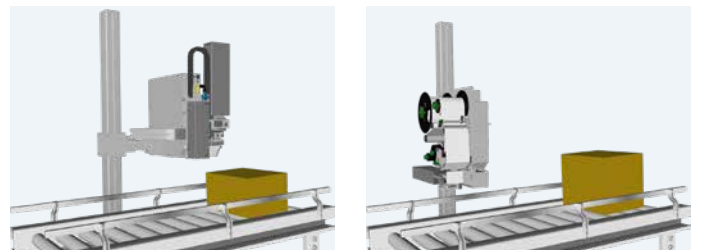

HERMES QL floor stands

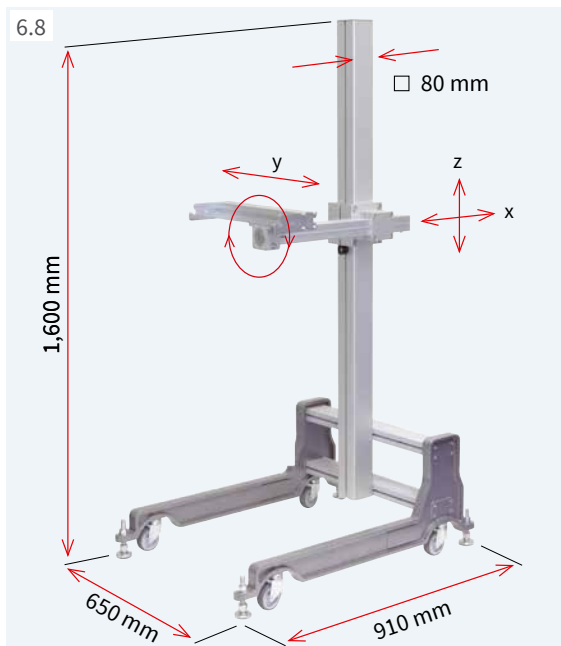

HERMES QL can be installed into a production line and aligned in three axes to an item to label. Pivoting is also possible.

Floor stand 1601

It benefits when operating HERMES Q in different production lines. Mobility is provided. At the place of operation, the floor stand can be fixed with the help of feet to adjust.

Floor stand		1601
Base frame		castors, leveling feet
Adjustment in height and depth		screw clamping
Load at offset 500 mm	kg max.	50
Weight	kg	36

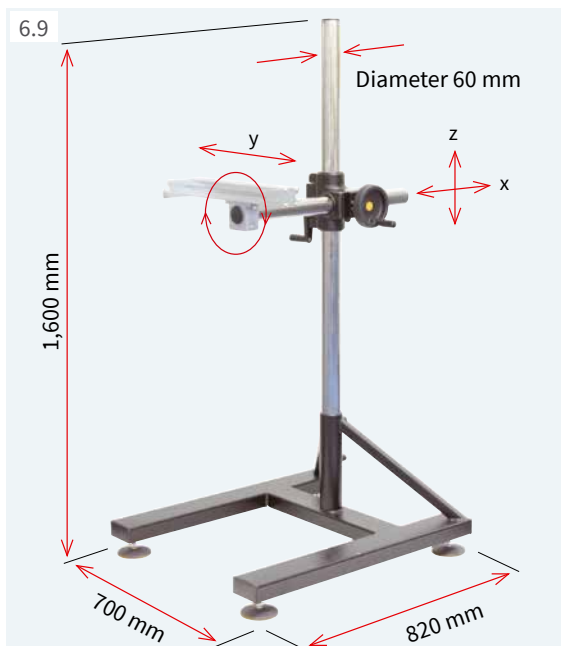

Floor stand 1602

It benefits if positions to apply labels are changing frequently in terms of heights and depths. HERMES QL can be aligned in directions x and z to a product using a toothed rack.

Floor stand		1602
Base frame		leveling feet
Adjustment in height in depth		toothed rack / crank toothed rack / handwheel
Load at offset 500 mm	kg max.	50
Weight	kg	38

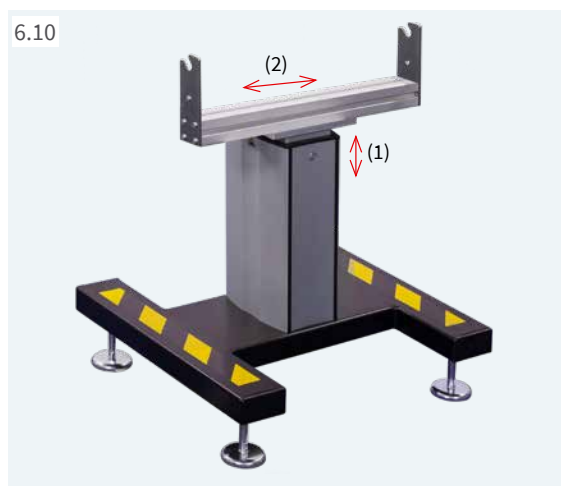

Floor stand 1201

for installing HERMES QL horizontally into a production line. Heights can be adjusted continuous using an integral spindle.

A unit to regulate compressed air can be assembled to the bracket, so can a warning light.

Floor stand		1201
Leveling feet	adjustable by mm	± 15
Load	kg max.	75
(1) Lower label margin to floor ¹⁾	mm	720 - 960
(2) Depth along direction of transport	mm	± 100
Weight	kg approx.	40

¹⁾ further dimensions upon request

HERMES QL delivery program

Label printers L

Pos.	Item no.	Designation
1.1		6012002 HERMES QL4.3L/200 label printer
	6012000 HERMES QL4.3L/300 label printer	

xxxxxxx.250 if HERMES QL provides options

Label printers R

Pos.	Item no.	Designation
1.1		6012012 HERMES QL4.3R/200 label printer
	6012010 HERMES QL4.3R/300 label printer	

xxxxxxx.250 if HERMES QL provides options

Scope of delivery

HERMES QL label printer
Type E+F power cable, 1.8 m
Connecting USB cable, 1.8 m
Instructions DE / EN





Provided online



<https://setup.cab.de/en>

Assembly instructions DE / EN / FR
Configuration manuals DE / EN / FR
Service manuals DE / EN
Spare parts lists DE / EN
Programming manuals EN
Windows printer drivers certified WHQL for
Windows 10 Server 2016
Windows 11 Server 2019
Server 2022
Apple Mac OS X printer drivers DE / EN / FR
Linux printer drivers DE / EN / FR
cablabel S3 Lite software
cablabel S3 Viewer
Database Connector

Wear parts

Pos.	Item no.	Designation	dpi
		5977382.001 Print head 4.3	200
	5977383.001 Print head 4.3	300	
		6012025.001 DRL4 print roller	
		6012079.001 Blade	
		6012078.001 Cutter bar	





















See current data also on the Internet:
www.cab.de/en/hermesql

Options

Pos.	Item no.	Designation
3.1		6012130 Cover 4L
	6012140 Cover 4R	
3.2		6010520.xxx 2 port Ethernet Switch 10/100 Mbit/s
3.3		5954180.xxx DR4 print roller

xxx - .250 assembled to a printer
.001 separate delivery













Accessories

Pos.	Item no.	Designation
2.1		5977370 SD memory card
2.2		5977730 USB stick
2.3		5978912 USB WLAN stick 2..4 GHz 802.11b/g/n
2.4		5977731 USB WLAN stick with a rod antenna 2.4 GHz 802.11b/g/n + 5 GHz a/n/ac
2.6		5970071 Product sensor, 3 pins
2.7		5964300 Product sensor, 25 pins
2.8		5917651 I/O interface plug, SUB-D, 25 pins
2.9		6010560 Warning light
2.10		6010186 External operation panel
		5907718.850 Connecting USB cable, 1.8 m
		5907730.850 Connecting USB cable, 3 m
		5907750.850 Connecting USB cable, 5 m
		5907760.850 Connecting USB cable, 11 m
		5907765.850 Connecting USB cable, 16 m
2.11		5948205 Label selection - I/O box
2.12		5955710 TR2 hand switch
2.13		5955711 Foot switch
2.14		5550818 Connecting RS232-C cable, 9/9 pins, 3 m

Scopes of delivery, design and technical specifications correspond to the date of the printing. Subject to change. The data provided in the catalog do not represent any warranty or guarantee.

HERMES QL delivery program

Assembly assistance

Pos.	Item no.	Designation
6.1	 5965940	Adapter plate
6.2	 5958365 Profile 40  5965929 Profile 80  5971721 Profile 120  5987701 Profile 160  5987702 Profile 200  5987703 Profile 300	Profile 40 Profile 80 Profile 120 Profile 160 Profile 200 Profile 300
6.3	 5961203	Base plate 500 x 255 mm
6.4	 5989277	Base plate, xy stop and product sensor included
6.5	 5955685	Bracket
6.6	 8914443	Clamped joint designed for a 50 x 50 mm profile
6.7	 8914444	Flanged joint designed for a 50 x 50 mm profile

Floor stands

Pos.	Item no.	Designation
6.8	 5970113	Floor stand 1601
6.9	 5970112	Floor stand 1602
6.10	 5972515	Floor stand 1201

Label software







Pos.	Part no.	Designation	
	Bundle	cablabel S3 Lite (download on cab.de/en)	
7.6		5588001 cablabel S3 Pro, 1 WS 5588100 cablabel S3 Pro, 5 WS 5588101 cablabel S3 Pro, 10 WS 5588150 cablabel S3 Pro, 1 additional licence 5588151 cablabel S3 Pro, 4 additional licences 5588152 cablabel S3 Pro, 9 additional licences	
		5588002 cablabel S3 Print, 1 WS 5588105 cablabel S3 Print, 5 WS 5588106 cablabel S3 Print, 10 WS 5588155 cablabel S3 Print, 1 additional licence 5588156 cablabel S3 Print, 4 additional licences 5588157 cablabel S3 Print, 9 additional licences	
		in preparation cablabel S3 Print Server	
	7.10	9008486	Programming manual EN, printed copy

User languages

Language	Assembly instructions	Operation panel	Windows driver	Service manual	cablabel S3
European Union					
Bulgarian		X	X		X
Danish	X	X	X		
German	X	X	X	X	X
Estonian		X	X		
Finnish	X	X	X		
French	X	X	X		X
Greek		X	X		
English	X	X	X	X	X
Italian	X	X	X		X
Croatian		X	X		
Latvian		X	X		
Lithuanian		X	X		
Dutch	X	X	X		
Polish	X	X	X		X
Portuguese	X	X	X		
Romanian	X	X	X		
Swedish	X	X	X		
Slovak		X	X		
Slovenian	X	X	X		
Spanish	X	X	X		X
Czech	X	X	X		X
Hungarian	X	X	X		
Europe (Non-EU)					
Macedonian		X	X		
Norwegian		X	X		
Russian	X	X	X		X
Serbian		X	X		
Turkish		X	X		
Asia					
Chinese (simplified)	X	X	X		X
Chinese (traditional)	X	X	X		X
Japanese		X	X		
Korean	X	X	X		X
Thai		x	X		
Middle East					
Arabian		X			
Persian		X			

Delivery program of applicators

HQ linerless applicators L



Pos.	Item no.	Designation	Item no.	Transfer modules
4.1	 5989285 5989286 5989287 5989288	Stroke applicator Stroke applicator Stroke applicator Stroke applicator	HQ 4024L-200 HQ 4024L-300 HQ 4024L-400 HQ 4024L-600	5989301 5989302 5989303 Tamp-on pad, spring-mounted Tamp-on pad, spring-mounted Tamp-on pad, spring-mounted 4024-3000 105 x 100 4024-3000 105 x 150 4024-3000 105 x 200
4.3	 5987520 5987521 5987522 5989343	Front side applicator Front side applicator Front side applicator Front side applicator	HQ 3014L-200 HQ 3014L-300 HQ 3014L-400 HQ 3014L-600	xxxxxxx xxxxxxx xxxxxxx Tamp-on pad Tamp-on pad, spring-mounted Blow-on pad 3014L-1100 W x H 3014L-3100 W x H 3014L-2100 W x H
4.4	 5987736 5987738 5987740	Stroke blow applicator Stroke blow applicator Stroke blow applicator	HQ 4614L-200 HQ 4614L-300 HQ 4614L-400	xxxxxxx Blow-on pad 4614L-2100 W x H
4.5	 5987534 5987535 5987536 5987537	Stroke applicator Stroke applicator Stroke applicator Stroke applicator	HQ 4014L-200 HQ 4014L-300 HQ 4014L-400 HQ 4014L-600	5966147 5966148 5966149 5966150 xxxxxxx xxxxxxx xxxxxxx xxxxxxx xxxxxxx Universal pad Universal pad Universal pad, spring-mounted Universal pad, spring-mounted Tamp-on pad Blow-on pad Tamp-on pad, spring-mounted Roll-on pad Corner-wrap pad 4014L-1100 75 x 60 4014L-1100 90 x 90 4014L-3100 116 x 102 4014L-3100 116 x 152 4014L-11 F W x H 4014L-2100 W x H 4014L-3100 W x H 4014L-4100 W x H 4014L-5100 W x H / H
4.6	 5972870 5987552 5989291	Vacuum belt applicator Vacuum belt applicator Vacuum belt applicator	HQ 5314L-2 HQ 5314L-3 HQ 5314L-4	
4.7	 5987714 5989294	Vacuum belt applicator Vacuum belt applicator	HQ 5414L-3 HQ 5414L-4	
4.8	 5987564	Air jet box 5 templates are included	HQ 6114L	5984709.001 Template 5 items are included in a pack unit 6114 L/R

xxxxxxx - customer-specific part no. subsequent to request



HQI InNo-Liner applicators L

Pos.	Item no.	Designation	Item no.	Transfer modules
4.2	 5989315 5989316 5989317 upon request	Stroke applicator Stroke applicator Stroke applicator Stroke applicator	HQI 4034L-200 HQI 4034L-300 HQI 4034L-400 HQI 4034L-600	5989301 5989302 5989303 Tamp-on pad, spring-mounted Tamp-on pad, spring-mounted Tamp-on pad, spring-mounted 4024-3000 105 x 100 4024-3000 105 x 150 4024-3000 105 x 200

Applicator accessories

Pos.	Item no.	Designation
5.13	 5964277.001 5964095.001	Blow tube 2" Blow tube 4"
5.14	 6010880 6010881	Unit L to regulate compressed air Unit R to regulate compressed air
5.16	 5984805 5984795	Unit L to regulate compressed air, providing a shut-off valve Unit R to regulate compressed air, providing a shut-off valve

Applicator options

Pos.	Item no.	Designation
5.17	 596xxxx.212	Pressure-reducing valve xxxx - applicator item no.
5.18	 596xxxx.220	Pressure-reduced applicator suitable for HQ 4014 / stroke 300 xxxx - applicator item no.

Delivery program of applicators

HQ linerless applicators R

Pos.	Item no.	Designation	Item no.	Transfer modules		
4.1	 5989295 5989296 5989297 5989298	Stroke applicator Stroke applicator Stroke applicator Stroke applicator	HQ 4024R-200 HQ 4024R-300 HQ 4024R-400 HQ 4024R-600	5989301 5989302 5989303 Tamp-on pad, spring-mounted Tamp-on pad, spring-mounted Tamp-on pad, spring-mounted	4024-3000 105 x 100 4024-3000 105 x 150 4024-3000 105 x 200	
4.3	 5987526 5987527 5987528 5989354	Front side applicator Front side applicator Front side applicator Front side applicator	HQ 3014R-200 HQ 3014R-300 HQ 3014R-400 HQ 3014R-600	xxxxxxx xxxxxxx xxxxxxx Tamp-on pad Tamp-on pad, spring-mounted Blow-on pad	3014R-1100 W x H 3014R-3100 W x H 3014R-2100 W x H	
4.4	 5987742 5987744 5987746	Stroke blow applicator Stroke blow applicator Stroke blow applicator	HQ 4614R-200 HQ 4614R-300 HQ 4614R-400	xxxxxxx Blow-on pad	4614R-2100 B x H	
4.5	 5987538 5987539 5987540 5989363	Stroke applicator Stroke applicator Stroke applicator Stroke applicator	HQ 4014R-200 HQ 4014R-300 HQ 4014R-400 HQ 4014R-600	5966140 5966141 5966142 5966143 xxxxxxx xxxxxxx xxxxxxx xxxxxxx xxxxxxx	Universal pad Universal pad Universal pad, spring-mounted Universal pad, spring-mounted Tamp-on pad Blow-on pad Tamp-on pad, spring-mounted Roll-on pad Corner-wrap pad	4014R-1100 75 x 60 4014R-1100 90 x 90 4014R-3100 116 x 102 4014R-3100 116 x 152 4014R-11 F W x H 4014R-2100 W x H 4014R-3100 W x H 4014R-4100 W x H 4014R-5100 W x H / H
4.6	 5987708 5987556 5989357	Vacuum belt applicator Vacuum belt applicator Vacuum belt applicator	HQ 5314R-2 HQ 5314R-3 HQ 5314R-4			
4.7	 5987716 5989360	Vacuum belt applicator Vacuum belt applicator	HQ 5414R-3 HQ 5414R-4			
4.8	 5987565	Air jet box 5 templates are included	HQ 6114R	5984709.001 Template 5 items are included in a pack unit	6114 L/R	

xxxxxxx - customer-specific part no. subsequent to request

HQI InNo-Liner applicators R

Pos.	Item no.	Designation	Item no.	Transfer modules	
4.2	 5989325 5989326 5989327 auf Anfrage	Stroke applicator Stroke applicator Stroke applicator Stroke applicator	HQI 4034R-200 HQI 4034R-300 HQI 4034R-400 HQI 4034R-600	5989301 5989302 5989303 Tamp-on pad, spring-mounted Tamp-on pad, spring-mounted Tamp-on pad, spring-mounted	4024-3000 105 x 100 4024-3000 105 x 150 4024-3000 105 x 200

Germany

cab Produkttechnik GmbH & Co KG

Karlsruhe

Phone +49 721 6626 0

www.cab.de

France

cab Technologies S.à.r.l.

Niedermodern

Phone +33 388 722501

www.cab.de/fr

USA

cab Technology, Inc.

Chelmsford, MA

Phone +1 978 250 8321

www.cab.de/us

Mexico

cab Technology, Inc.

Juárez

Phone +52 656 682 4301

www.cab.de/es

Taiwan

cab Technology Co., Ltd.

Taipei

Phone +886 (02) 8227 3966

www.cab.de/tw

China

cab (Shanghai) Trading Co., Ltd.

Shanghai

Phone +86 (021) 6236 3161

www.cab.de/cn

Singapore

cab Singapore Pte. Ltd.

Singapore

Phone +65 6931 9099

www.cab.de/en

South Africa

cab Technology (Pty) Ltd.

Randburg

Phone +27 11 886 3580

www.cab.de/za

cab // 820 distribution and service partners in more than **80** countries