



Autofocus 1D and 2D Code Reader
SR-1000 Series



SETTING THE STANDARD FOR CODE READING

SR-1000 Series



SR-1000 Series

3 CHALLENGES

CODE READERS FACE

1

READER CANNOT BE MOUNTED AT DESIRED DISTANCE

“Selecting the right reader and lens combination for a given distance is frustrating.”
“The system has to be designed to fit the specifications of the reader.”



2

OPTIMUM SETTINGS ARE UNKNOWN

“Reading was successful during setup but there are many errors during actual operation.”
“Setup requires a whole day.”



3

READING FAILS DUE TO GLARE

“Do we need to mount the reader at a certain angle? What is the best angle?”
“Is external lighting required? What kind?”



1 ANSWER JUST PRESS THE BUTTON



PRESS THE BUTTON

1

AUTOFOCUS

The reader can be mounted at any distance.
(1000 mm max.)

2

AUTOMATIC TUNING

Determines optimum settings for exposure time,
image processing filter, etc. [Approx. 750000 combinations]

3

AUTOMATIC POLARISATION

Glare can be eliminated. Reader angle adjustment or
external lighting becomes unnecessary.

SET-UP COMPLETE



Autofocus 1D and 2D code reader
SR-1000 Series



WORLD'S FIRST AUTOMATIC POLARISATION CONTROL

The reader features both polarised and direct light sources.
Automatic polarisation filter selection eliminates glare and
allows flexible mounting.

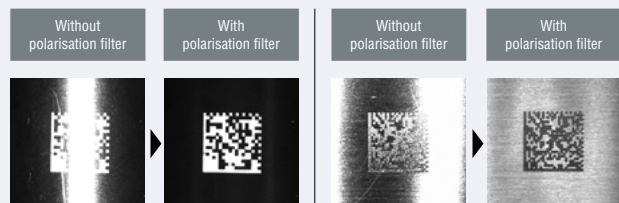

1

EASY SET-UP BY "JUST PRESSING THE BUTTON"

AUTOFOCUS

ONE READER FOR MANY APPLICATIONS

Mounting is less restricted by the performance or specifications of the code reader itself, thus improving flexibility in machine designing for production lines and jigs.

A single reader can be used for targets with different heights

Provides safe movement range for a robotic arm

Reading extremely small codes



FIELD OF VIEW 4x LARGER

Conventional field of view

Field of view of the SR-1000 Series

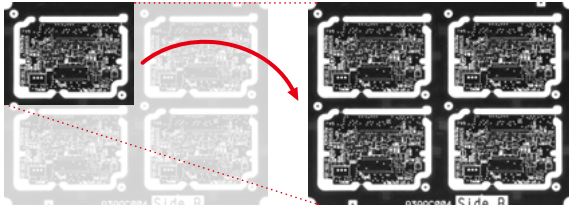

EVEN IF THE CODE IS

SMALL

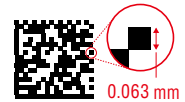

0.063 mm

Distance: 110 mm

Range: 290 mm x 220 mm

4x WIDER
than conventional models

EVEN IF THE POSITION
CHANGES



Distance: 1000 mm

1.6x LONGER
than conventional models

EVEN IF THE DISTANCE IS
FAR

















AUTOMATIC TUNING

OPTIMUM SETTING OF EXPOSURE TIME, FILTERS AND MORE

The code reader automatically optimises the exposure time, image processing filter and other parameters according to the target and mounting distance.

CLEAR IMAGE CAPTURE

CORRECTION ITEMS AND EXAMPLES OF AFFECTED CODES

 <p>Dark</p>	<p>CAPTURE BRIGHTNESS CORRECTION</p> <p>Automatically configures various combinations of exposure time, dynamic range and gain in order to achieve the optimal brightness.</p>	 <p>Black resin</p>	 <p>PCB</p>
 <p>Low contrast</p>	<p>CONTRAST THRESHOLD CORRECTION</p> <p>Automatically corrects black/white thresholds and optimises the contrast between code and background.</p>	 <p>Metal</p>	 <p>Ceramic</p>
 <p>Thin printing</p>	<p>FILTER CORRECTION</p> <p>Automatically selects the best filter and filtering intensity to correct the captured image.</p>	 <p>Bleeding</p>	 <p>Thick printing</p>
 <p>Distortion</p>	<p>GEOMETRIC CORRECTION</p> <p>Corrects distorted codes, such as those on cylinders and other round surfaces or when the reader is mounted at an angle.</p>	 <p>Parallel distortion</p>	 <p>Trapezoidal distortion</p>
 <p>Stray dots</p>	<p>IMAGE REDUCTION & CORRECTION</p> <p>Reducing the image size may reduce background noise or missing spaces. Defects from background noise, dirt or scratches may appear insignificant after the image size reduction, hence causing them to be neglected.</p>	 <p>Primary noise</p>	 <p>Dot printing</p>

APPLICATIONS

Transportation and metal works industries

CRANKSHAFTS

INSPECTIONS

The large field of view and autofocus function compensate for changes in both the position and reading distance of codes between product types.

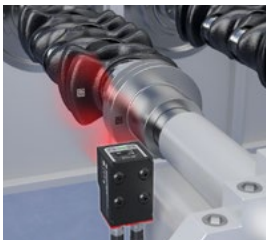

Electronic devices industry

LEAD FRAMES

BONDING

This single device enables reading of extremely small codes and codes discoloured by heat or oxidation.



Food, medical, and packaging industries

RETOUR FOOD PRODUCTS

VARIETY INSPECTIONS

When transporting products on a conveyor belt, processing over a large field of view and with high-speed correction is possible even if the positions and orientations of the barcodes are different.



CAMSHAFTS

PROCESSING

Automatic elimination of glare caused by cylindrical metals allow for stable reading.



IC CHIPS

INSPECTIONS

Simultaneous reading of component codes for multiple ICs in a tray is possible.

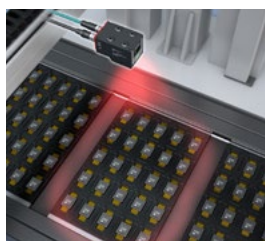

MEDICINAL PACKAGING

PACKAGING

With reliable capturing of barcodes and 2D codes traveling at high speeds help contribute to ever-increasing safety checks.



3 EASY SET-UP BY "JUST PRESSING THE BUTTON"





AUTOMATIC POLARISATION CONTROL

ENSURING FLEXIBLE MOUNTING

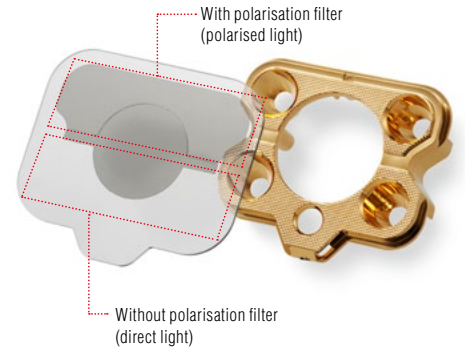
Automatic polarisation control function World's First

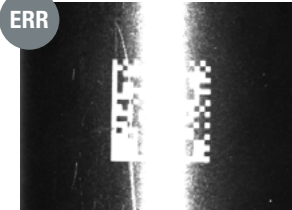
The code reader automatically removes glare and eliminates the need for mounting angle adjustment or external lighting during installation. When combined with the autofocus function, mounting becomes highly flexible.

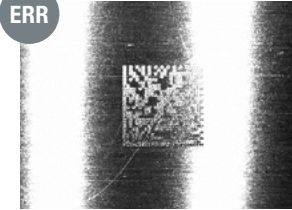
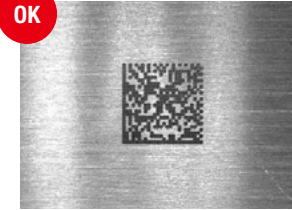

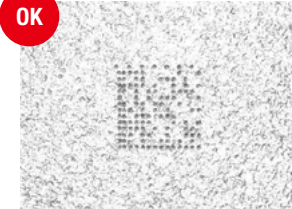
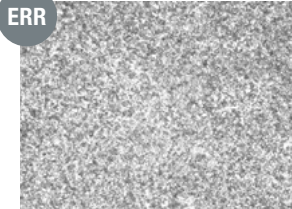
		Without polarisation filter	With polarisation filter
BLACK RESIN			
METAL			
METAL			

NEW OPTICAL DESIGN FOR STABLE READING

CPC (Compound Parabolic Concentrator) Illumination

A specially shaped reflector has been designed to create high efficiency illumination by reducing loss in light intensity from the high intensity LEDs. Gold plating maximises the reflectance to achieve brightness exceeding conventional levels by 400%. This provides reading under bright, uniform illumination even at long ranges.

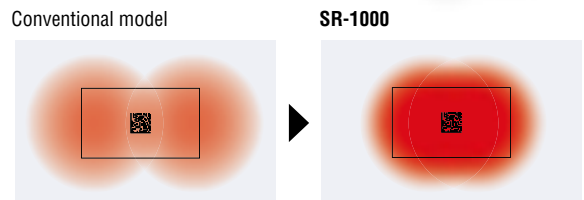

Light is concentrated efficiently within the field of view to provide high intensity illumination.

TWO MODES CAN BE SELECTED DEPENDING ON THE APPLICATION



UNAFFECTED BY CHANGING CONDITIONS

SMART MODE NEW

FOR CONSISTENT READING REGARDLESS OF CODE CONDITIONS



LOW CONTRAST CODE

Fluctuations in code conditions are predicted during tuning and extended reading settings are automatically generated. This ensures stable reading even when the contrast of the code changes, eliminating the need to reconfigure the code reader.

The reader predicts 43 patterns of alternative printing conditions.

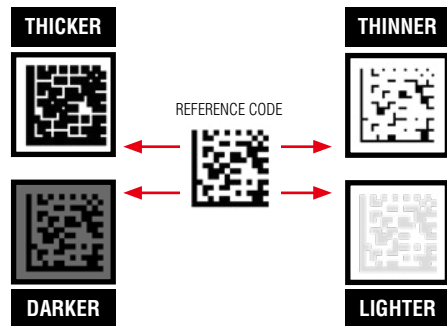

DETECTING CHANGES IN CODE CONDITIONS

CUSTOM MODE

FOR CODE QUALITY MANAGEMENT

The SR-1000 has the functionality to make judgements on code quality. Because code quality degradation can be detected before reading errors occur, this mode can be used for predictive maintenance of the printing process.

Matching level judgement function

Provides code quality comparison

Two codes, which both have a reading rate of 100%, can still be distinguished by the matching level



Reading rate **100%**
Matching level **75**



Reading rate **100%**
Matching level **43**

Code quality verification function

Verification based on code quality standards

OUTPUT DATA **AD-ERMT-55841:B**

TOTAL GRADE JUDGEMENT

Judgement can also be given for each parameter



SUPPORTED STANDARDS

- ISO/IEC 15415
- ISO/IEC TR 29158 (AIM DPM-1-2006)
- ISO/IEC 16022
- SAE AS9132
- SEMI T10-0701

*This function is designed for 2D codes (QR, DataMatrix, GS1 Composite, PDF417).

EASY-TO-USE HIGH PERFORMANCE

ADVANCED SETUP SOFTWARE

SR-H7W



The software now provides not only easy code reader setup but also functionality to reduce man-hours for preliminary tests. It is possible to connect to the software through USB.

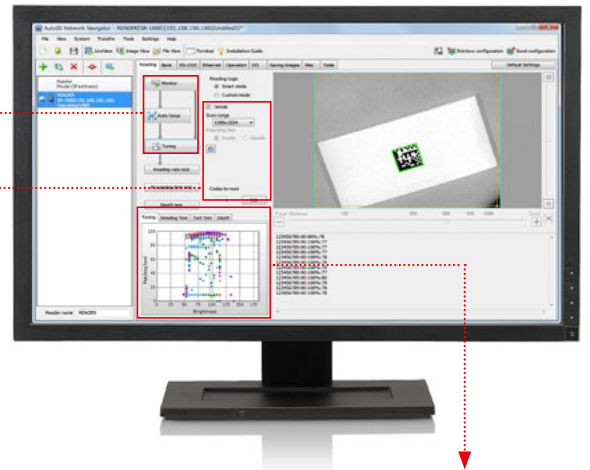
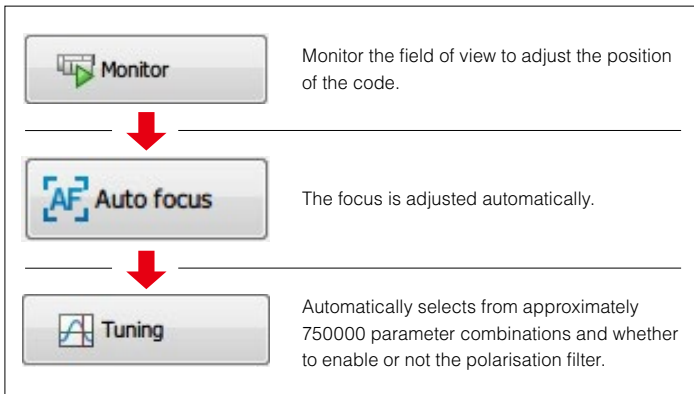

ADVANCED SETTINGS

Details

Image capture range: 1280x1024

Polarizing filter: Enable Disable

Bank to Tune/Test: 1

Test with target bank

Codes to read: 1

IMAGE CAPTURE RESOLUTION

The lower the resolution, the shorter the reading time becomes. The image capture resolution is selectable from 800 x 600, 1280 x 1024 and user defined.

TARGET BANK (in custom mode only)

Specify the parameter bank number to modify.

POLARISATION FILTER

Selectable between enabled or disabled.

TUNING HISTORY (in custom mode only)

Tuning history can be reviewed.

NO. OF CODES FOR READING

Specify the number of codes to read simultaneously.

TUNING MONITOR

The optimum settings are automatically determined from multiple combinations of image processing filters and brightness levels.

ETHERNET COMMUNICATION WIZARD NEW

Setup can be completed in just four steps with a question-answer form including visual explanations. In previous versions, the user had to understand the available settings on the screen and determine which items are required to be input. The new version uses a setup wizard to eliminate the need for item extraction, reducing man-hours for communication setup.

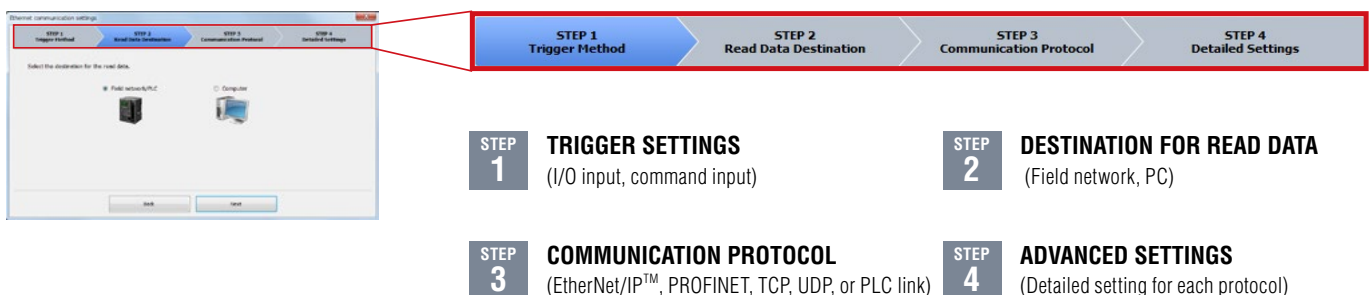

SOPHISTICATED MEASUREMENT MODES

The SR-1000 Series provides pre-verification prior to line operation based on tuning results as well as measurement of applicable line speed for reading codes at high speeds.

READING RATE MEASUREMENT

The reading success rate can be measured without conducting reading tests with multiple targets on the actual production line or equipment.

Tuning	Reading Test	Tact Test	Depth
Reading Test	100%		
Matching level	97		
Symbology	DataMatrix(12 x 12)		
Cell size	1.00mm		
Code size (width)	12.0mm		
PPC	25.0pixel/cell		
Read Data	123456789		

READING TACT MEASUREMENT

The reading cycle time (tact) can be determined without conducting reading tests with targets on the actual production line or equipment.

Tuning	Reading Test	Tact Test	Depth
Read time	32ms		
Max time	33ms		
Min time	32ms		
Read Data	123456789		

READING DEPTH MEASUREMENT NEW

The depth of field can be determined from the mounting distance and the code used for tuning, without conducting reading tests with targets on the actual production line or equipment.

(When the mounting distance changes, perform re-tuning to enable reading again.)

Tuning	Reading Test	Tact Test	Depth
Installation distance	175mm		
Reading depth	110mm		
Near depth	-55mm		
Far depth	+55mm		

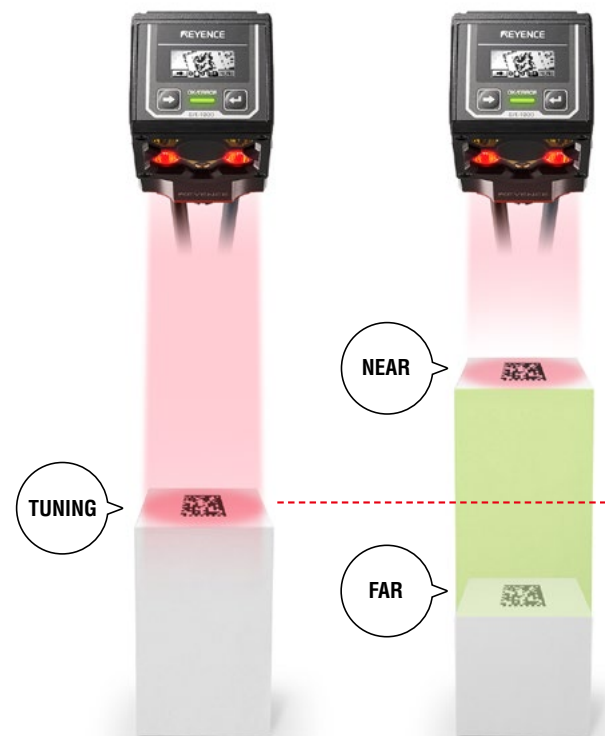

LINE SPEED MEASUREMENT NEW

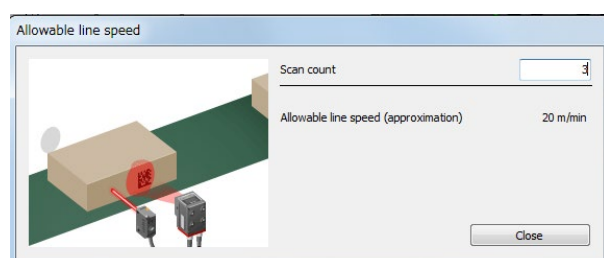

You can check allowable line speed before installation. This helps to reduce man-hours that are spent to adjust the production line designs or jigs.

FIRST-IN-ITS-CLASS, BUILT-IN OLED DISPLAY

CHECK OPERATION ON-SITE WITHOUT A PC

There is no need for a personal computer or monitoring the facility. The code position adjustment and operating condition can be checked simply with the intuitive built-in display.

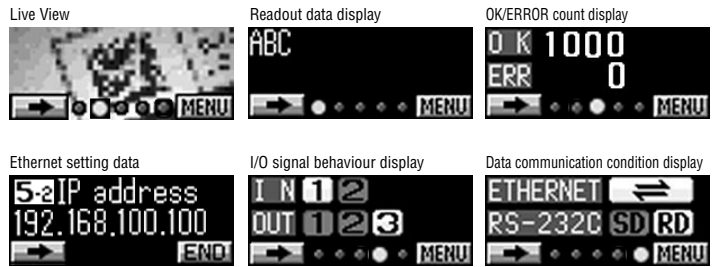

EASY SETUP WITHOUT A PC

You can set the optimum reading parameters after adjusting the code position and simply pressing the ENTER button to complete the fully-automatic tuning.

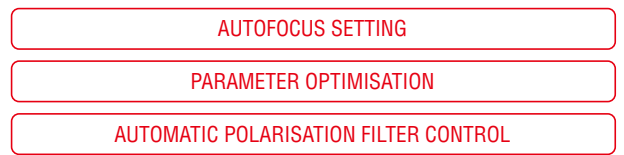
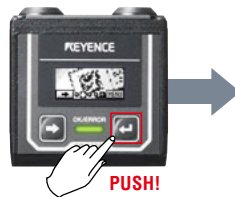

Reading test starts automatically.

HIGHLY-ADVANCED FUNCTIONS OFFER SIMPLE OPERATION

MASTER/SLAVE FUNCTION FOR USING MULTIPLE READERS EFFICIENTLY

The master station can control up to 31 slave stations when multiple readers are used. (Up to 7 stations can be controlled in multi-head mode.) This function drastically reduces the programming load on the host computer/PLC.

* SR-D100/750 Series units can also be added (in combination with SR-1000 Series units) into this function.

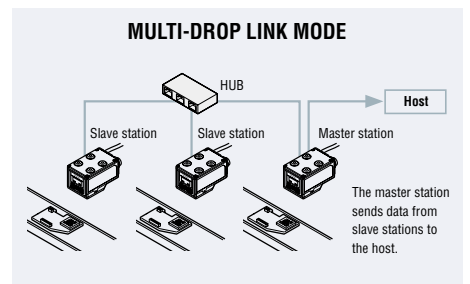
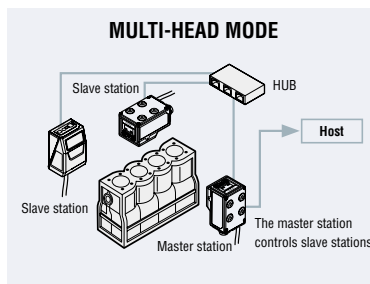

Communication and control via EtherNet/IP™ and PROFINET are also possible. (Only in multi-head mode)

TOOLING CHANGE FUNCTION UTILISES UP TO 8 CONFIGURATION FILES

By importing settings stored in ROM via a command, switching is possible even if the reading conditions (code type, marking style, reading distance) are completely different.

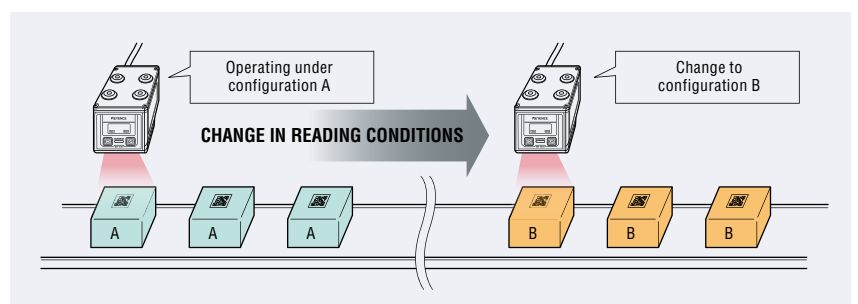

Switching instructions via EtherNet/IP™ and PROFINET is also possible.

HIGH-SPEED SEARCH

2D CODE SEARCH IN CAPTURED IMAGES

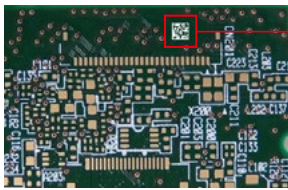

Binary processing enables immediate detection of 2D codes even if there is a code-like pattern in the field of view.

ADVANCED DETECTION

DEFECTIVE CODE POSITIONING PROGRAM

A newly developed positioning program for defective codes can identify the four corners of a 2D code based on a similar code detection pattern, leading to a significant improvement in code detection performance.

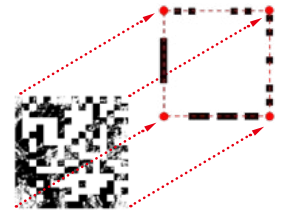

HIGH-LEVEL DECODING

CONTRAST ALGORITHM FOR LOCAL CONCENTRATION (CALC)

Our contrast algorithm for local concentration divides a code into smaller pieces to perform binary processing using thresholds specified for each division. This enables accurate black/white classification without being affected by uneven print density.

CONVENTIONAL TECHNIQUE

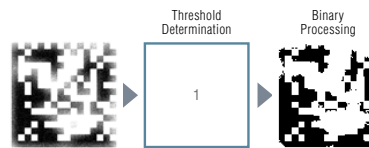

CALC TECHNIQUE



* The above illustration is only an example and it does not mean that a code will always be divided into 16 parts.

AUTOMATIC SELECTION OF OPTIMAL READING CONDITIONS (PARAMETER BANK FUNCTION)

CUSTOM MODE ONLY

The reader will automatically alternate between registered parameter banks until a required parameter bank is selected.

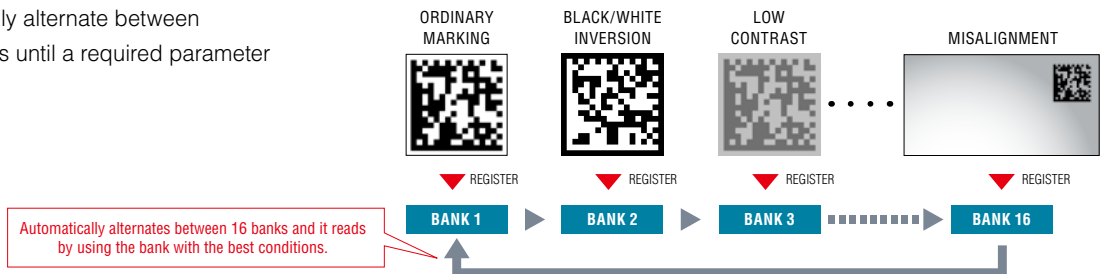

SUSTAINABLE PERFORMANCE DURING MULTIPLE READING PROCESSES

RELIABLE READING THANKS TO BUILT-IN DUAL CORE PROCESSOR

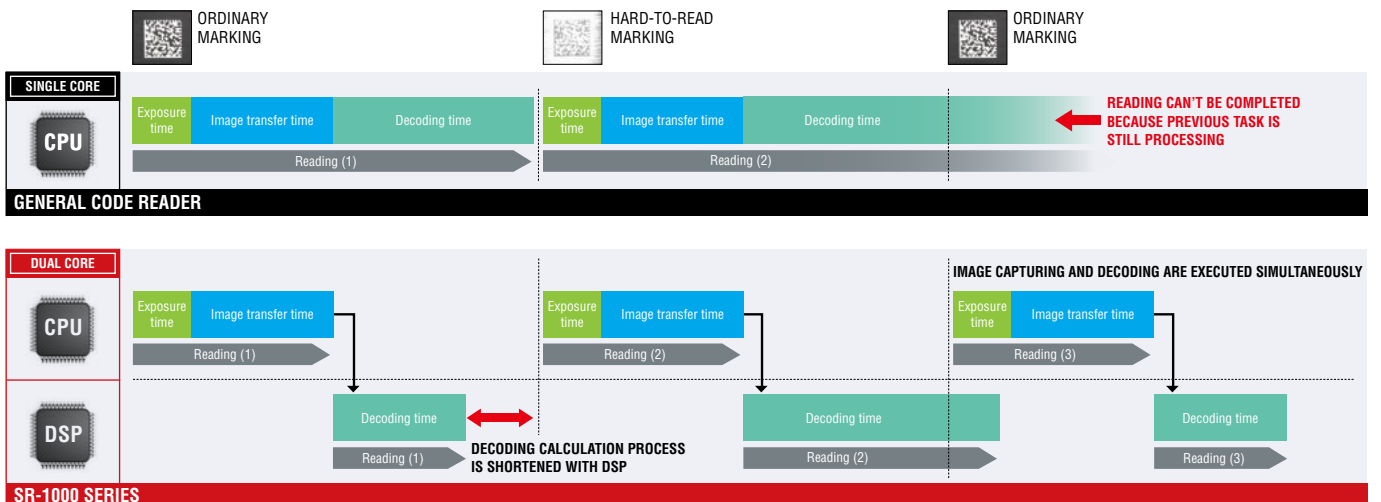

COMPATIBILITY WITH VARIOUS COMMUNICATION PROTOCOLS

Built-in EtherNet/IP™, PROFINET, and PLC link protocols make PLC connections easier. In addition, general-purpose TCP/IP and FTP communication are also supported. With FTP communication, transmission of not only images but also text data is also possible.



Connection information for various PLC types can be found here: www.barcodereader.com/

CUSTOMISABLE OUTPUT FORMATS USING DATA EDIT FUNCTION

Thanks to customisable output formats for the code reader, programming corrections on the host side (PC, PLC, etc.) is not required, allowing for shorter data processing times.

(EXAMPLES OF DATA EDIT FUNCTION IN USE)

Extracting specific data



Adding additional information to image file names



Controlling OUT output signals

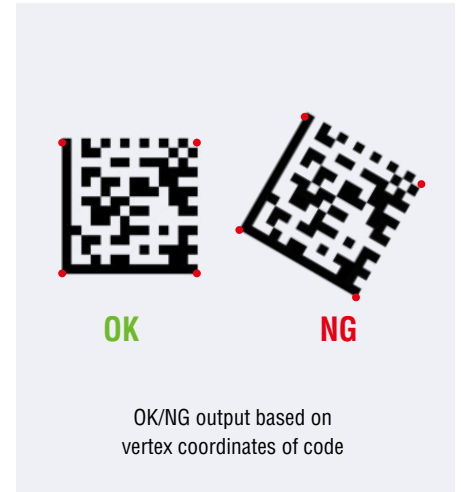

CONVENIENT SOFTWARE TOOLS ALSO PROVIDED

1. Specification examination and installation preparation

2. Operational testing and maintenance

3. Simple operations

Installation Guide

The reading distance, field of view, and moving speed can be checked based on the code size.

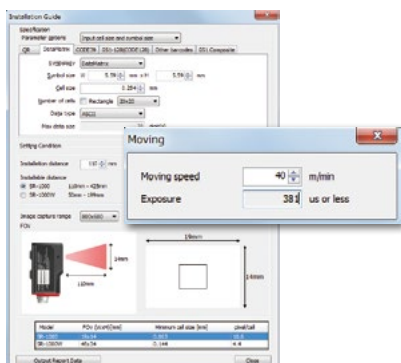

AutoID Terminal

Establishing direct communication with the code reader allows problems due to communication failure to be isolated.

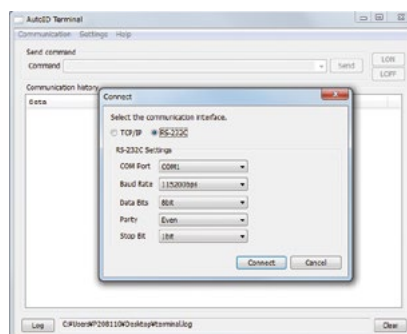

AutoID Keyboard Wedge

Input using the PC's keyboard interface is possible.

Both Windows and Mac versions are available.

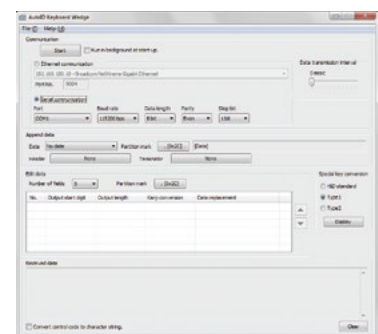

Ensures stable reading of codes with a minimum resolution of 0.025 mm

HIGH RESOLUTION ATTACHMENT SR-10AH

Improved reading of extremely small codes and codes printed on mirror finished surfaces.

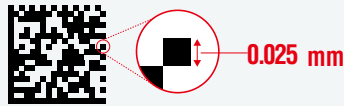

Field of View: Increased by 4.5 times

Comparison with conventional models
Mounting distance 40 mm
When the image capturing range is 800 × 600 pixels

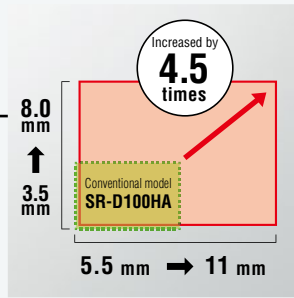

Good installation distance for extremely small codes

When KEYENCE's test codes are used
Cell size 0.04 mm



Highly flexible mounting

Comparison with conventional models

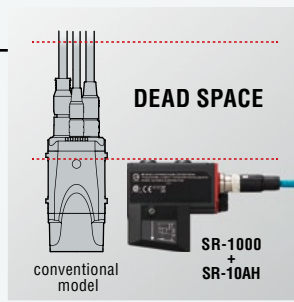

Automatic control of optimal reading conditions

When auto-tuning is enabled

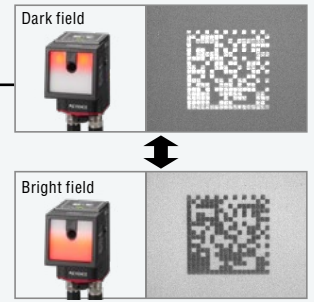

APPLICATION EXAMPLES

Micro-size sample (chip LED)

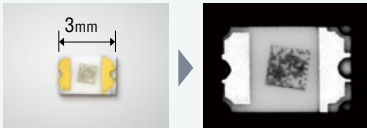

Mirror finished surface (wafer)

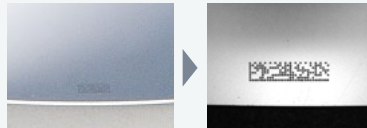

Metal (IC package)

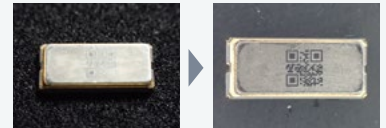

Superior reading of codes printed on mirror finished surfaces

REFLECTOR ATTACHMENT SR-10AR

By changing the reflected light of mirror finished surfaces to diffuse light, it's possible to achieve the same effect as when using external lighting.



When SR-10AR is not used

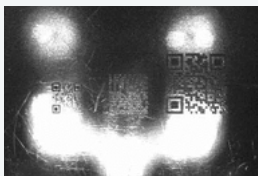

When SR-10AR is used



Reduces the costs of jigs and man-hour for installation

ADJUSTABLE BRACKET OP-88002

This bracket allows the reader to be attached in any position along either the vertical or horizontal axis.

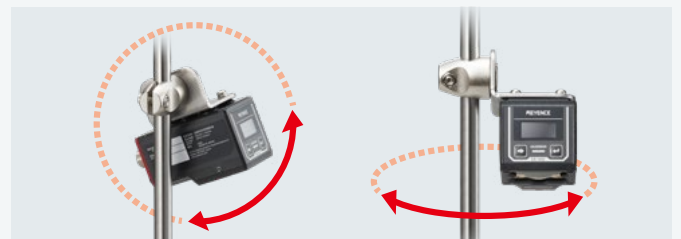
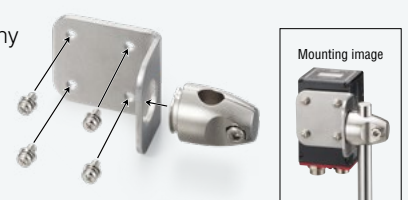

SYSTEM CONFIGURATION DIAGRAM

SR-1000 Series



Option

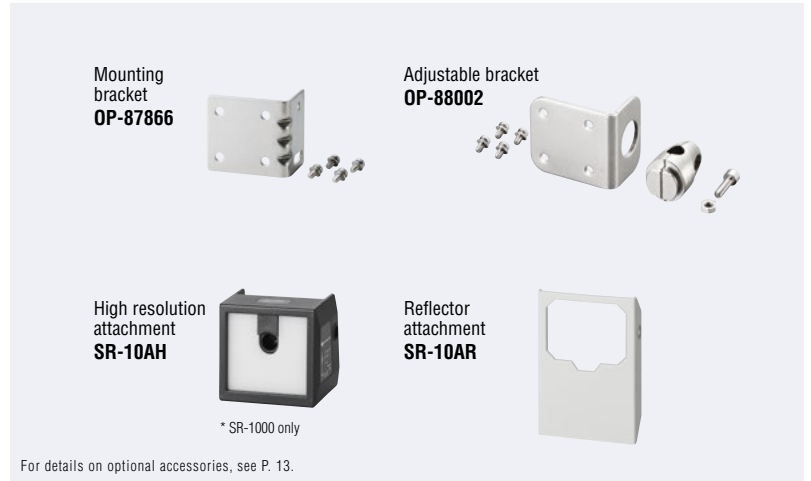

Cable

	Control cable					Ethernet cable (NFPA79-compliant)		USB cable (USB-A to Mini-B)
	NFPA79-compliant					-	Right angle connector	
	-		Right angle connector					
	-		D-sub 9-pin connector	-		D-sub 9-pin connector		
2 m	OP-87224	OP-87353	OP-87527	OP-88304	OP-88307	OP-87230	OP-88301	OP-51580
5 m	OP-87225	OP-87354	OP-87528	OP-88305	OP-88308	OP-87231	OP-88302	OP-86941
10 m	OP-87226	OP-87355	OP-87529	OP-88306	OP-88309	OP-87232	OP-88303	-

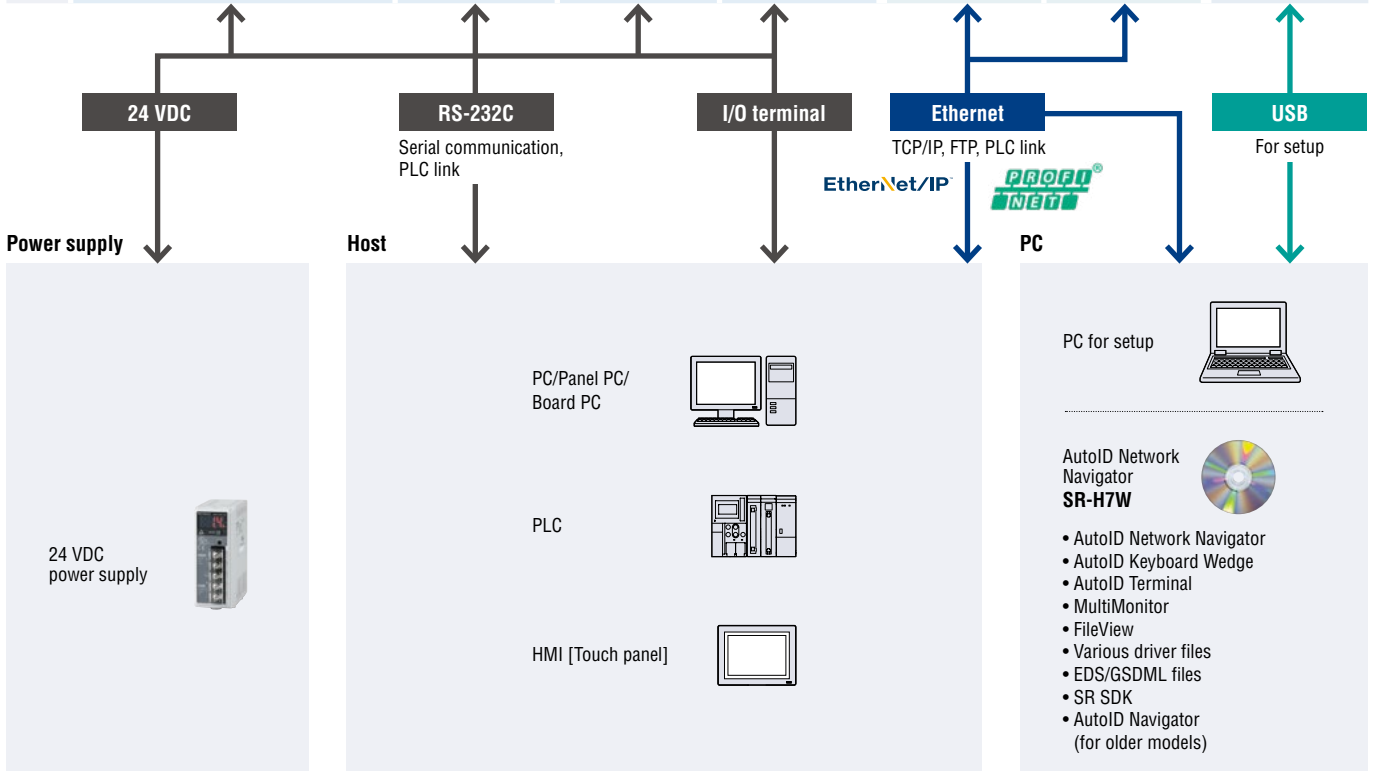

READING RANGE CHARACTERISTICS [TYPICAL]

SR-1000

MINIMUM RESOLUTION

Distance	Unit (mm)	
	2D	Barcode
110	0.063	0.082
110 to 140	0.082	
110 to 230	0.14	
110 to 300	0.18	0.11
110 to 400	0.24	0.15
110 to 600	0.37	0.22
110 to 1000	0.61	0.37

FIELD OF VIEW

Distance	Unit (mm)			
	Image capture range (1280 × 1024 pixels)		Image capture range (800 × 600 pixels)	
	Width	Height	Width	Height
110	30	24	19	14
140	40	32	25	18
230	68	54	42	32
300	90	72	56	42
400	122	97	76	57
600	185	148	116	87
1000	312	250	195	146

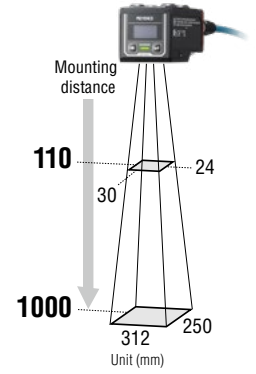

SR-1000W

MINIMUM RESOLUTION

Distance	Unit (mm)	
	2D	Barcode
50	0.082	0.082
50 to 100	0.14	
50 to 150	0.20	0.12
50 to 230	0.30	0.18
50 to 300	0.38	0.23
50 to 400	0.51	0.31
50 to 600	0.76	0.45

FIELD OF VIEW

Distance	Unit (mm)			
	Image capture range (1280 × 1024 pixels)		Image capture range (800 × 600 pixels)	
	Width	Height	Width	Height
50	35	28	22	16
100	67	54	42	31
150	99	79	62	46
230	150	120	93	70
300	194	155	121	91
400	257	206	161	120
600	384	307	240	180

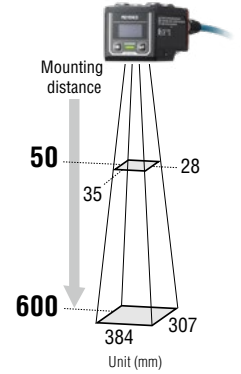

SR-1000 + SR-10AH

MINIMUM RESOLUTION

Distance	Unit (mm)	
	2D	Barcode
20	0.025	0.082
20 to 30	0.03	
20 to 40	0.04	

FIELD OF VIEW

Distance	Unit (mm)			
	Image capture range (1280 × 1024 pixels)		Image capture range (800 × 600 pixels)	
	Width	Height	Width	Height
20	11	9	7	5
30	15	12	9	7
40	19	15	11	8

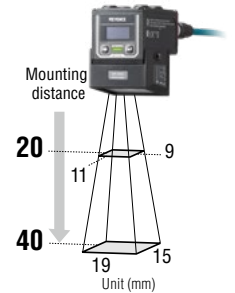

DIMENSIONS

Main unit
SR-1000/1000W

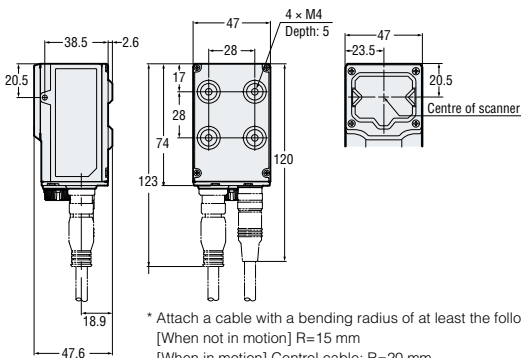

* Attach a cable with a bending radius of at least the following values.
 [When not in motion] R=15 mm
 [When in motion] Control cable: R=20 mm
 Ethernet cable: R=50 mm

With right angle connector

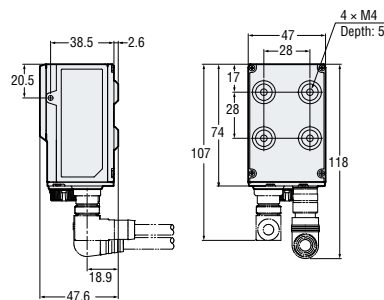

Adjustable bracket
OP-87866

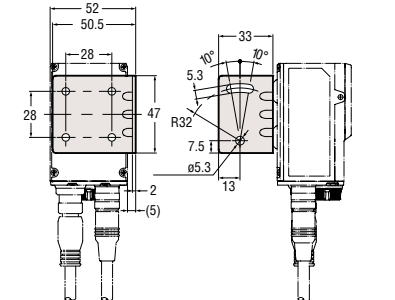

High resolution attachment
SR-10AH

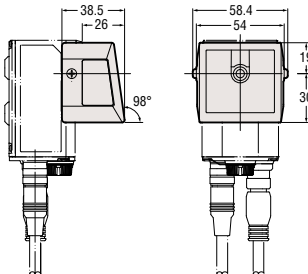

Reflector attachment
SR-10AR

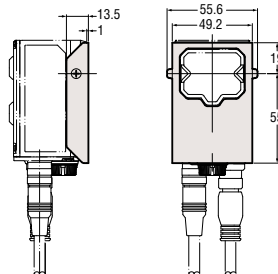

Adjustable bracket
OP-88002

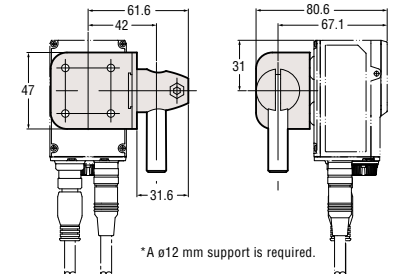

* A ø12 mm support is required.

SPECIFICATIONS



Main unit

Model*2		SR-1000	SR-1000W	SR-1000+SR-10AH	
Type		Standard type	Wide-field type	When the high resolution attachment is used	
Receiver	Sensor	CMOS Image Sensor			
	Number of pixels	1280 × 1024 pixels			
Light emitter	Illumination light source	High intensity red LED			
	Pointer light source	High intensity green LED			
Focus adjustment		Autofocus*			
Reading specifications	Supported symbol	2D	QR, MicroQR, DataMatrix (ECC200), GS1 DataMatrix, PDF417, MicroPDF417, GS1 Composite (CC-A/CC-B/CC-C)		
		Barcode	CODE39, ITF, 2of5 (Industrial 2of5), CODP 2of5, NW-7 (Codabar), CODE128, GS1-128, GS1 DataBar, CODE93, JAN/EAN/UPC, Trioptic CODE39, CODE39 Full ASCII, Pharmacode		
	Minimum resolution	2D	0.063 mm	0.082 mm	0.025 mm
		Barcode	0.082 mm	0.082 mm	0.082 mm
Reading distance		110 to 1000 mm	50 to 600 mm	20 to 40 mm	
Field of view for reading		122 × 97 mm (Typical example at 400 mm)	257 × 206 mm (Typical example at 400 mm)	19 × 15 mm (Typical example at 40 mm)	
I/O specifications	Control input	Number of inputs	2		
		Input type	Bidirectional voltage input		
		Maximum rating	26.4 VDC		
		Minimum ON voltage	15 VDC		
		Maximum OFF current	0.2 mA or less		
	Control output	Number of outputs	3		
		Output type	Photo MOS relay output		
		Maximum rating	30 VDC		
		Maximum load current	1 output: 50 mA or less, Total of 3 outputs: 100 mA or less		
		Leakage current when OFF	0.1 mA or less		
		Residual voltage when ON	1 V or less		
	Ethernet	Communication standard	IEEE 802.3 compliant, 10BASE-T/100BASE-TX		
		Supported protocol	TCP/IP, SNT, FTP, BOOTP, MC protocol, Omron PLC link, KV STUDIO, EtherNet/IP™, PROFINET		
	Serial communication	Communication standard	RS-232C compliant		
		Transmission speed	9600, 19200, 38400, 57600, 115200 bps		
	USB	Supported protocol	No-protocol, MC protocol, SYSWAY, KV STUDIO		
Communication standard		USB 2.0 Full Speed compliant			
Environmental resistance	Enclosure rating	IP65			
	Ambient temperature	0 to +45°C			
	Ambient storage temperature	-10 to +50°C			
	Relative humidity	35 to 85% RH (No condensation)			
	Storage ambient humidity	35 to 85% RH (No condensation)			
	Ambient luminance	Sunlight: 10000 lux, Incandescent lamp: 6000 lux, Fluorescent lamp: 2000 lux			
	Operating environment	No dust or corrosive gas present			
Vibration	10 to 55 Hz Double amplitude 0.75 mm, 3 hours each in X, Y and Z directions				
Rating	Power voltage	24 VDC ±10%			
	Current consumption	Approx. 700 mA	Approx. 250 g		
Weight		Approx. 200 g	Approx. 250 g		

* The focal position can be adjusted automatically during installation.
 • SR-1000N and SR-1000WN are available as supported models for India.

Setup software (AutoID Network Navigator)

Model	SR-H7W
Supported OS	Windows 10 Professional or later, 32 bit/64 bit Windows 8 Professional or later, 32 bit/64 bit (Except for Windows RT) Windows 7 Professional or later, 32 bit/64 bit
Running environment	Processor 2.0 GHz or higher, Memory 8 GB or more. Required free space on hard disk 1 GB or more (space is also required for saving SR Management Tool data) DVD-ROM drive required for installation, Screen resolution 1440 × 1080 or higher

- .NET Framework 4.6.1 or higher is installed.
- Microsoft Visual C++ redistributable packages (x86) for Visual Studio 2015, 2017, and 2019 are installed.
- Windows, Visual Studio, Microsoft Edge, Internet Explorer, and Excel are either registered trademarks or trademarks of Microsoft Corporation in the United States and/or other countries.

SR SERIES LINEUP

Ultra-compact 1D and
2D Code Reader
SR-700 Series



Compact 1D and
2D Code Reader
SR-750 Series



Please visit: www.keyence.com



SAFETY INFORMATION

Please read the instruction manual carefully in order to safely operate any KEYENCE product.

GLOBAL NETWORK

CONTACT YOUR NEAREST OFFICE FOR RELEASE STATUS

AUSTRIA
Phone: +43 (0)2236 378266 0

CZECH REPUBLIC
Phone: +420 220 184 700

INDIA
Phone: +91-44-4963-0900

MALAYSIA
Phone: +60-3-7883-2211

ROMANIA
Phone: +40 (0)269 232 808

TAIWAN
Phone: +886-2-2721-8080

BELGIUM
Phone: +32 (0)15 281 222

FRANCE
Phone: +33 1 56 37 78 00

INDONESIA
Phone: +62-21-2966-0120

MEXICO
Phone: +52-55-8850-0100

SINGAPORE
Phone: +65-6392-1011

THAILAND
Phone: +66-2-369-2777

BRAZIL
Phone: +55-11-3045-4011

GERMANY
Phone: +49-6102-3689-0

ITALY
Phone: +39-02-6688220

NETHERLANDS
Phone: +31 (0)40 206 6100

SLOVAKIA
Phone: +421 (0)2 5939 6461

UK & IRELAND
Phone: +44 (0)1908-696-900

CANADA
Phone: +1-905-366-7655

HONG KONG
Phone: +852-3104-1010

JAPAN
Phone: +81-6-6379-2211

PHILIPPINES
Phone: +63-(0)2-8981-5000

SLOVENIA
Phone: +386 (0)1 4701 666

USA
Phone: +1-201-930-0100

CHINA
Phone: +86-21-5058-6228

HUNGARY
Phone: +36 1 802 7360

KOREA
Phone: +82-31-789-4300

POLAND
Phone: +48 71 368 61 60

SWITZERLAND
Phone: +41 (0)43 455 77 30

VIETNAM
Phone: +84-24-3772-5555